



**OWNER'S MANUAL  
MANUEL DU PROPRIÉTAIRE  
BEDIENUNGSANLEITUNG**

**PW50  
MOTORCYCLE  
MOTO  
MOTORRAD**

**⚠ Read this manual carefully before operating this vehicle.**

**⚠ Il convient de lire attentivement ce manuel avant la première utilisation du véhicule.**

**⚠ Bitte lesen Sie diese Bedienungsanleitung sorgfältig durch, bevor Sie das Fahrzeug in Betrieb nehmen.**

***PW50  
PW50R***

**BSL-28199-81**

Original instructions  
Notice originale  
Originalbetriebsanleitung



PRINTED IN JAPAN  
2023.03-2.6x1 CR (E,F,G)



## OWNER'S MANUAL

# PW50

## MOTORCYCLE

 Read this manual carefully before operating this vehicle.

*PW50*  
*PW50R*

BSL-28199-81-E0

 **Read this manual carefully before operating this vehicle. This manual should stay with this vehicle if it is sold.**

**EC Declaration of Conformity**  
conforming to Directive 2006/42/EC

We, **YAMAHA MOTOR CO., LTD.** 2500 Shingai, Iwata, Japan,  
declare in sole responsibility, that the product

**PW50 (JYA3PT00000596543-)**

(Make, model)

to which this declaration applies, conforms to the essential  
health and safety requirements of Directive 2006/42/EC

(If applicable)

and to the other relevant Directives of EEC  
**2014/30/EU**

(Title and/or number and date of issue of the other Directives of EEC)

(If applicable)

To effect correct application of the essential health and safety  
requirements stated in the Directives of EEC, the following-standards  
and/or technical specifications were consulted:

**EN16029**

(Title and/or number and date of issue of standards and/or specifications)

**Manufacturer**

YAMAHA MOTOR CO.,LTD.  
2500 SHINGAI IWATA SHIZUOKA, JAPAN

**Authorized Representative**

YAMAHA MOTOR EUROPE N.V.  
Kooihovenlaan 101, 1119 NC Schiphol-Rijk, The Netherlands

Signature

  
Yuichi Takeda

Senior General Manager.  
PF Model Development Section  
YAMAHA MOTOR CO., LTD.

Date of Issue 30 , Jan, 2023

**UK  
CA**

**Declaration of Conformity**  
In accordance with UK Government guidance

We, **YAMAHA MOTOR CO., LTD.** 2500 Shingai, Iwata, Japan,  
declare in sole responsibility, that the product

**PW50 (JYA3PT00000596543-)**

(Make, model)

The object of the declaration described above is in conformity with the  
relevant UK Statutory instruments (and their amendments):

No. 1597 The Supply of Machinery (Safety) Regulations 2008

No. 1091 The Electromagnetic Compatibility Regulations 2016

References to the relevant designated standards used or references to  
the other technical specifications in relation to which conformity is  
declared:

**BS-EN16029**

(Title and/or number and date of issue of standards and/or specifications)

**Manufacturer**

YAMAHA MOTOR CO.,LTD.  
2500 SHINGAI IWATA SHIZUOKA, JAPAN

**Authorized Representative**

YAMAHA MOTOR EUROPE N.V. BRANCH UK  
Units A2 - A3, Kingswey Business Park, Forsyth Road, Woking, Surrey, GU21 5SA, UK

Signature

  
Yuichi Takeda

Senior General Manager.  
PF Model Development Section  
YAMAHA MOTOR CO., LTD.

Date of Issue 30 , Jan, 2023

Congratulations on your purchase of the Yamaha PW50 / PW50R. This model is the result of Yamaha's vast experience in the production of fine sporting, touring, and pacesetter racing machines. It represents the high degree of craftsmanship and reliability that have made Yamaha a leader in these fields.

This manual will give you an understanding of the operation, inspection, and basic maintenance of this motorcycle. If you have any questions concerning the operation or maintenance of your motorcycle, please consult a Yamaha dealer.

The design and manufacture of this Yamaha motorcycle fully comply with the emissions standards for clean air applicable at the date of manufacture. Yamaha has met these standards without reducing the performance or economy of operation of the motorcycle. To maintain these high standards, it is important that you and your Yamaha dealer pay close attention to the recommended maintenance schedules and operating instructions contained within this manual.

Yamaha continually seeks advancements in product design and quality. Therefore, while this manual contains the most current product information available at the time of printing, there may be minor discrepancies between your motorcycle and this manual. If there is any question concerning this manual, please consult a Yamaha dealer.

EWA10032

## **WARNING**

**Please read this manual carefully and completely before operating this motorcycle.**

EWA14352

## **WARNING**

**This motorcycle is designed and manufactured for off-road use only. It is illegal to operate this motorcycle on any public street, road or highway. Such use is prohibited by law. This motorcycle complies with almost all state off-highway noise level and spark arrester laws and regulations. Please check your local riding laws and regulations before operating this motorcycle.**

### **AN IMPORTANT SAFETY MESSAGE:**

- Read this manual carefully and completely before operating this motorcycle. Make sure you understand all instructions.
- Pay close attention to the warning and notice labels on the motorcycle.
- Never operate a motorcycle without proper training or instruction.
- Weight of the rider should not exceed 25 kg (55 lb).

### **AN IMPORTANT NOTE TO PARENTS:**

This motorcycle is not a toy. Before you let your child ride this motorcycle, you should understand the instructions and warnings in this Owner's Manual. Then be sure your child understands and will follow them. Children differ in skills, physical abilities, and judgment. Some children may not be able to operate a motorcycle

# Introduction

---

safely. Parents should supervise their child's use of the motorcycle at all times. Parents should permit continued use only if they determine that the child has the ability to operate the motorcycle safely.

Your motorcycle is equipped with an adjustable speed limiter and a power reduction plate. Yamaha recommends that all beginners start off with the speed limiter adjusting screw turned in and the power reduction plate installed in the exhaust manifold to limit the power available while they learn. The limiter screw may be gradually turned out to increase maximum speed as the beginner becomes more familiar with operating the motorcycle. Parents should decide when to adjust the motorcycle for more power as their youngster's riding skills improve. Once the rider can operate with skill at the top speed permitted by adjusting the speed limiter alone, the power reduction plate can be removed. Since removal of this plate will result in a significant increase in power, turn the speed limiter back in again; adjust it out in stages as you did before.

**Motorcycles are single track vehicles. Their safe use and operation are dependent upon the use of proper riding techniques as well as the expertise of the operator. Every operator should know the following requirements before riding this motorcycle.**





He or she should:

- Obtain thorough instructions from a competent source on all aspects of motorcycle operation.
- Observe the warnings and maintenance requirements in this Owner's Manual.
- Obtain qualified training in safe and proper riding techniques.
- Obtain professional technical service as indicated in this Owner's Manual and/or when made necessary by mechanical conditions.

# Important manual information

EAU63350

Particularly important information is distinguished in this manual by the following notations:

	<b>This is the safety alert symbol. It is used to alert you to potential personal injury hazards. Obey all safety messages that follow this symbol to avoid possible injury or death.</b>
	<b>A WARNING indicates a hazardous situation which, if not avoided, could result in death or serious injury.</b>
	<b>A NOTICE indicates special precautions that must be taken to avoid damage to the vehicle or other property.</b>
	<b>A TIP provides key information to make procedures easier or clearer.</b>

\*Product and specifications are subject to change without notice.

EAU10201

**PW50 / PW50R  
OWNER'S MANUAL  
©2024 by Yamaha Motor Co., Ltd.  
1st edition, February 2023  
All rights reserved.  
Any reprinting or unauthorized use  
without the written permission of  
Yamaha Motor Co., Ltd.  
is expressly prohibited.  
Printed in Japan.**

# Table of contents

---

<b>Location of important labels</b> .....	1-1	Checking the spark plug .....	7-6
<b>Safety information</b> .....	2-1	Removing the power reduction plate .....	7-7
<b>Description</b> .....	3-1	Transmission oil .....	7-8
Left view .....	3-1	Middle and final gear cases .....	7-10
Right view .....	3-2	Cleaning the air filter element .....	7-10
Controls and instruments .....	3-3	Cleaning the spark arrester .....	7-11
<b>Instrument and control functions</b> ..	4-1	Adjusting the carburetor .....	7-12
Handlebar switch .....	4-1	Adjusting the engine idling speed .....	7-13
Speed limiter and power reduction plate .....	4-1	Checking the throttle grip free play .....	7-14
Front brake lever .....	4-2	Tires .....	7-14
Rear brake lever .....	4-3	Panel wheels .....	7-16
Fuel tank cap .....	4-3	Adjusting the front and rear brake lever free play .....	7-17
Fuel .....	4-4	Checking the front and rear brake shoes .....	7-18
Fuel tank breather hose .....	4-5	Checking and lubricating the cables .....	7-19
2-stroke engine oil .....	4-6	Checking and lubricating the throttle grip and cable .....	7-19
Fuel cock .....	4-6	Adjusting the Autolube pump .....	7-20
Starter (choke) lever .....	4-7	Lubricating the front and rear brake levers .....	7-20
Kickstarter .....	4-7	Checking and lubricating the centerstand .....	7-21
Seat .....	4-8	Checking the front fork .....	7-21
Cable lock (for Europe) .....	4-9	Checking the steering .....	7-22
<b>For your safety – pre-operation checks</b> .....	5-1	Checking the wheel bearings .....	7-22
<b>Operation and important riding points</b> .....	6-1	Front wheel .....	7-23
Starting and warming up a cold engine .....	6-1	Rear wheel .....	7-24
Starting a warm engine .....	6-2	Troubleshooting .....	7-27
Starting off .....	6-2	Troubleshooting chart .....	7-28
Acceleration and deceleration .....	6-3	<b>Motorcycle care and storage</b> .....	8-1
Braking .....	6-3	Matte color caution .....	8-1
Engine break-in .....	6-4	Care .....	8-1
Parking .....	6-4	Storage .....	8-3
<b>Periodic maintenance and adjustment</b> .....	7-1	<b>Specifications</b> .....	9-1
Owner's tool kit .....	7-2	<b>Consumer information</b> .....	10-1
Periodic maintenance chart for the emission control system .....	7-3	Identification numbers .....	10-1
General maintenance and lubrication chart .....	7-4	Reporting safety defects (For CANADA customers) .....	10-3



# Table of contents

---

Index .....	11-1
-------------	------

# Location of important labels

EAU68710

1

Read and understand all of the labels on your vehicle. They contain important information for safe and proper operation of your vehicle. Never remove any labels from your vehicle. If a label becomes difficult to read or comes off, a replacement label is available from your Yamaha dealer.

## For Canada

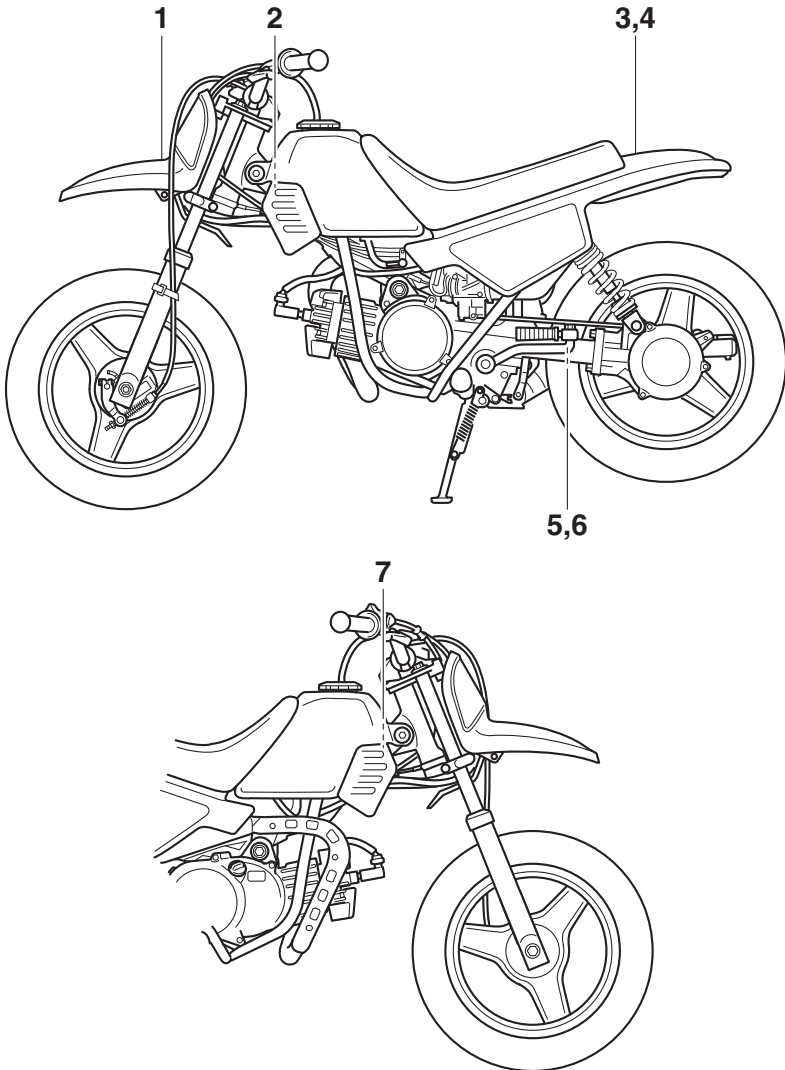

# Location of important labels

## For Canada

1



2



3



4

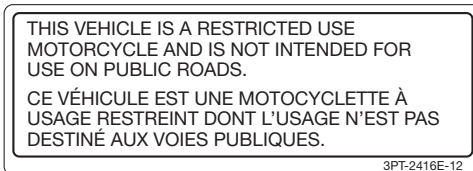

1

# Location of important labels

---

## For Canada

5

### TIRE INFORMATION

Cold tire normal pressure should be set as follows.

**FRONT** : 100 kPa, {1.00 kgf/cm<sup>2</sup>}, 15 psi

**REAR** : 100 kPa, {1.00 kgf/cm<sup>2</sup>}, 15 psi

3VR-21668-A1

6

### INFORMATION SUR LES PNEUS

La pression des pneus à froid doit normalement être réglée comme suit.

**AVANT** : 100 kPa, {1.00 kgf/cm<sup>2</sup>}, 15 psi

**ARRIERE**: 100 kPa, {1.00 kgf/cm<sup>2</sup>}, 15 psi

3VR-21668-B1

7

CAN ICES-002 / NMB-002

8KM-82377-32

# Location of important labels

For Europe

1

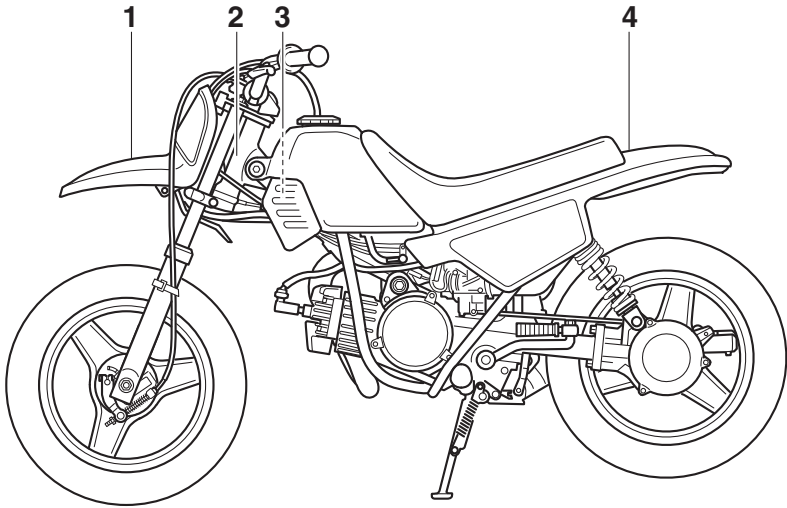

# Location of important labels

## For Europe

1

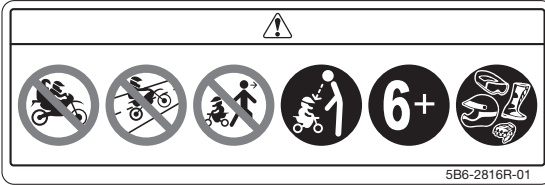

2

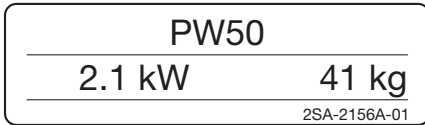

3

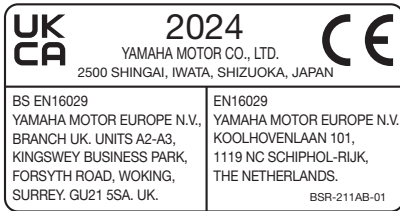



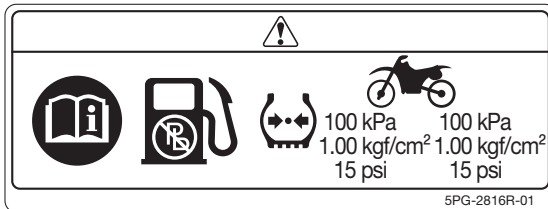

4







# Location of important labels

Familiarize yourself with the following pictograms and read the explanatory text.

	Read the Owner's manual.
	Always use an approved helmet and protective gear.
	Use from 6 years old. Operation of this motorcycle by children under the age of 6 increase the risk of severe injury or death.
	Adult supervision required for children.
	Never use on paved roads.
	Never carry passengers.
	This unit contains high-pressure nitrogen gas. Mishandling can cause an explosion. Do not incinerate, puncture or open.

# Location of important labels

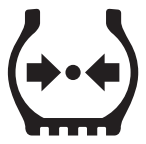
1

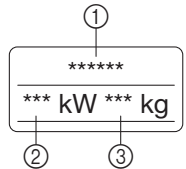
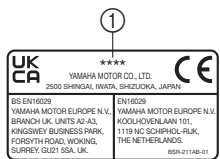
	<p>Turn off the main switch after riding to avoid draining the battery.</p>
	<p>Use unleaded gasoline only.</p>
	<p>Measure the tire pressure when the tires are cold.</p>
 <p>             **. kPa      **. kPa              **. kgf/cm<sup>2</sup>    **. kgf/cm<sup>2</sup>              **. psi        **. psi         </p>	<p>Adjust the tire pressure.              Improper tire pressure can cause loss of control.              Loss of control can result in severe injury or death.</p>
	<p>① Model Name              ② Max. Power              ③ Mass In Running Order</p>
	<p>① Year of construction</p>



# Location of important labels

For Oceania and South Africa

1

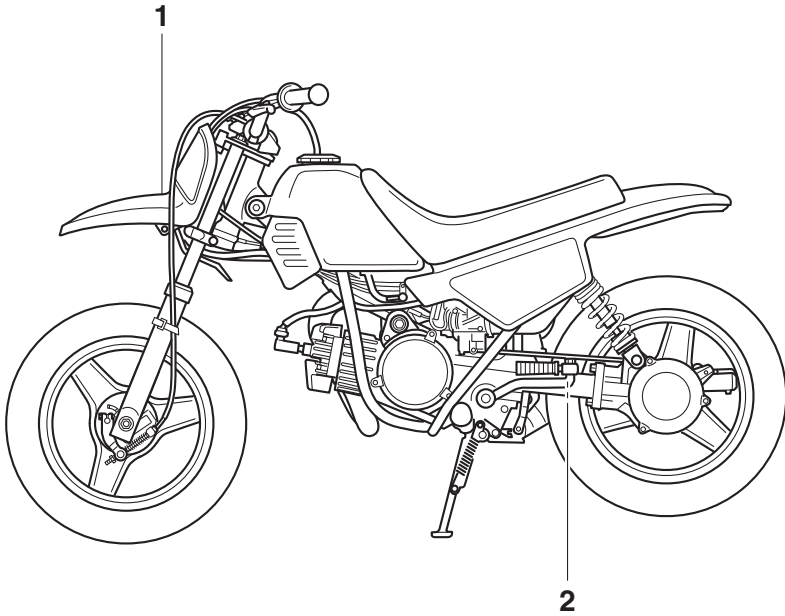

# Location of important labels

---

## For Oceania and South Africa

1

### **WARNING**

- **BEFORE YOU OPERATE THIS VEHICLE, READ THE OWNER'S MANUAL AND ALL LABELS.**
- **NEVER CARRY A PASSENGER.** You increase your risk of losing control if you carry a passenger.
- **NEVER OPERATE THIS VEHICLE ON PUBLIC ROADS.** You can collide with another vehicle if you operate this vehicle on a public road.
- **ALWAYS WEAR AN APPROVED MOTORCYCLE HELMET,** eye protection, and protective clothing.

3PT-2118K-A2

2

### **TIRE INFORMATION**

Cold tire normal pressure should be set as follows.

**FRONT** : 100 kPa, {1.00 kgf/cm<sup>2</sup>}, 15 psi

**REAR** : 100 kPa, {1.00 kgf/cm<sup>2</sup>}, 15 psi

3RV-21668-A1

EAU4093C

## Be a Responsible Owner

As the vehicle's owner, you are responsible for the safe and proper operation of your motorcycle.

Motorcycles are single-track vehicles. Their safe use and operation are dependent upon the use of proper riding techniques as well as the expertise of the operator. Every operator should know the following requirements before riding this motorcycle.

He or she should:

- Obtain thorough instructions from a competent source on all aspects of motorcycle operation.
- Observe the warnings and maintenance requirements in this Owner's Manual.
- Obtain qualified training in safe and proper riding techniques.
- Obtain professional technical service as indicated in this Owner's Manual and/or when made necessary by mechanical conditions.
- Never operate a motorcycle without proper training or instruction. Take a training course. Beginners should receive training from a certified instructor. Contact an authorized motorcycle dealer to find out about the training courses nearest you.

## Safe Riding

Perform the pre-operation checks each time you use the vehicle to make sure it is in safe operating condition. Failure to inspect or maintain the vehicle properly increases the possibility of

an accident or equipment damage. See page 5-1 for a list of pre-operation checks.

- This motorcycle is designed for off-road use only, therefore, it is illegal to operate it on public streets, roads, or highways, even a dirt or gravel one. Off-road use on public lands may be illegal. Please check local regulations before riding.
- This motorcycle is designed to carry the operator only. No passengers.
- The failure of motorists to detect and recognize motorcycles in traffic is the predominating cause of automobile/motorcycle accidents. Many accidents have been caused by an automobile driver who did not see the motorcycle. Making yourself conspicuous appears to be very effective in reducing the chance of this type of accident.

### Therefore:

- Wear a brightly colored jacket.
- Use extra caution when you are approaching and passing through intersections, since intersections are the most likely places for motorcycle accidents to occur.
- Ride where other motorists can see you. Avoid riding in another motorist's blind spot.
- Never maintain a motorcycle without proper knowledge. Contact an authorized motorcycle dealer to inform you on ba-

## Safety information

---

sic motorcycle maintenance. Certain maintenance can only be carried out by certified staff.

- Many accidents involve inexperienced operators.
  - Make sure that you are qualified and that you only lend your motorcycle to other qualified operators.
  - Know your skills and limits. Staying within your limits may help you to avoid an accident.
  - We recommend that you practice riding your motorcycle until you have become thoroughly familiar with the motorcycle and all of its controls.
- Many accidents have been caused by error of the motorcycle operator. A typical error made by the operator is veering wide on a turn due to excessive speed or undercornering (insufficient lean angle for the speed). Never travel faster than warranted by conditions.
- Ride cautiously in unfamiliar areas. You may encounter hidden obstacles that could cause an accident.
- The posture of the operator is important for proper control. The operator should keep both hands on the handlebar and both feet on the operator footrests during operation to maintain control of the motorcycle.
- Never ride under the influence of alcohol or other drugs.

### **Protective Apparel**

The majority of fatalities from motorcycle accidents are the result of head injuries. The use of a safety helmet is the single most critical factor in the prevention or reduction of head injuries.

- Always wear an approved helmet.
- Wear a face shield or goggles. Wind in your unprotected eyes could contribute to an impairment of vision that could delay seeing a hazard.
- The use of a jacket, heavy boots, trousers, gloves, etc., is effective in preventing or reducing abrasions or lacerations.
- Never wear loose-fitting clothes, otherwise they could catch on the control levers, footrests, or wheels and cause injury or an accident.
- Always wear protective clothing that covers your legs, ankles, and feet. The engine or exhaust system become very hot during or after operation and can cause burns.

### **Avoid Carbon Monoxide Poisoning**

All engine exhaust contains carbon monoxide, a deadly gas. Breathing carbon monoxide can cause headaches, dizziness, drowsiness, nausea, confusion, and eventually death.

Carbon Monoxide is a colorless, odorless, tasteless gas which may be present even if you do not see or smell any engine exhaust. Deadly levels of carbon monoxide can collect rapidly and you can quickly be overcome and unable to save yourself. Also, deadly levels of carbon monoxide can linger for hours or days in enclosed or poorly

ventilated areas. If you experience any symptoms of carbon monoxide poisoning, leave the area immediately, get fresh air, and SEEK MEDICAL TREATMENT.

- Do not run engine indoors. Even if you try to ventilate engine exhaust with fans or open windows and doors, carbon monoxide can rapidly reach dangerous levels.
- Do not run engine in poorly ventilated or partially enclosed areas such as barns, garages, or carports.
- Do not run engine outdoors where engine exhaust can be drawn into a building through openings such as windows and doors.

### Loading

Adding accessories to your motorcycle can adversely affect stability and handling if the weight distribution of the motorcycle is changed. To avoid the possibility of an accident, use extreme caution when adding accessories to your motorcycle. Use extra care when riding a motorcycle that has added accessories. Here are some general guidelines to follow if adding accessories to your motorcycle:

### Operation of an overloaded vehicle could cause an accident.

- The weight of the operator must not exceed 25 kg (55 lb).
- Accessory weight should be kept as low and close to the motorcycle as possible. Securely pack your heaviest items as close to the center of the vehicle as possible and make sure to distribute the

weight as evenly as possible on both sides of the motorcycle to minimize imbalance or instability.

- Shifting weights can create a sudden imbalance. Make sure that accessories are securely attached to the motorcycle before riding. Check accessory mounts frequently.
- Properly adjust the suspension for your load (suspension-adjustable models only), and check the condition and pressure of your tires.
- Never attach any large or heavy items to the handlebar, front fork, or front fender.

### Genuine Yamaha Accessories

Choosing accessories for your vehicle is an important decision. Genuine Yamaha accessories, which are available only from a Yamaha dealer, have been designed, tested, and approved by Yamaha for use on your vehicle.

Many companies with no connection to Yamaha manufacture parts and accessories or offer other modifications for Yamaha vehicles. Yamaha is not in a position to test the products that these aftermarket companies produce. Therefore, Yamaha can neither endorse nor recommend the use of accessories not sold by Yamaha or modifications not specifically recommended by Yamaha, even if sold and installed by a Yamaha dealer.

# Safety information

---

## **Aftermarket Parts, Accessories, and Modifications**

While you may find aftermarket products similar in design and quality to genuine Yamaha accessories, recognize that some aftermarket accessories or modifications are not suitable because of potential safety hazards to you or others. Installing aftermarket products or having other modifications performed to your vehicle that change any of the vehicle's design or operation characteristics can put you and others at greater risk of serious injury or death. You are responsible for injuries related to changes in the vehicle.

Keep the following guidelines in mind, as well as those provided under "Loading" when mounting accessories.

- Never install accessories that would impair the performance of your motorcycle. Carefully inspect the accessory before using it to make sure that it does not in any way reduce ground clearance or cornering clearance, limit suspension travel, steering travel or control operation.
- Accessories fitted to the handlebar or the front fork area can create instability due to improper weight distribution. If accessories are added to the handlebar or front fork area, they must be as lightweight as possible and should be kept to a minimum.
- Bulky or large accessories may seriously affect the stability of the motorcycle. Wind may at-

tempt to lift the motorcycle, or the motorcycle may become unstable in cross winds.

- Certain accessories can displace the operator from his or her normal riding position. This improper position limits the freedom of movement of the operator and may limit control ability, therefore, such accessories are not recommended.
- Use caution when adding electrical accessories. If electrical accessories exceed the capacity of the motorcycle's electrical system, an electric failure could result, which could cause a dangerous loss of lights or engine power.

## **Aftermarket Tires and Rims**

The tires and rims that came with your motorcycle were designed to match the performance capabilities and to provide the best combination of handling, braking, and comfort. Other tires, rims, sizes, and combinations may not be appropriate. Refer to page 7-14 for tire specifications and more information on replacing your tires.

## **Transporting the Motorcycle**

Be sure to observe following instructions before transporting the motorcycle in another vehicle.

- Remove all loose items from the motorcycle.
- Check that the fuel cock is in the "S" (stop) position and that there are no fuel leaks.

- Point the front wheel straight ahead on the trailer or in the truck bed, and choke it in a rail to prevent movement.
- Shift the transmission in gear (for models with a manual transmission).
- Secure the motorcycle with tie-downs or suitable straps that are attached to solid parts of the motorcycle, such as the frame or upper front fork triple clamp (and not, for example, to rubber-mounted handlebars or turn signals, or parts that could break). Choose the location for the straps carefully so the straps will not rub against painted surfaces during transport.
- The suspension should be compressed somewhat by the tie-downs, if possible, so that the motorcycle will not bounce excessively during transport.

# Description

EAU63371

## Left view

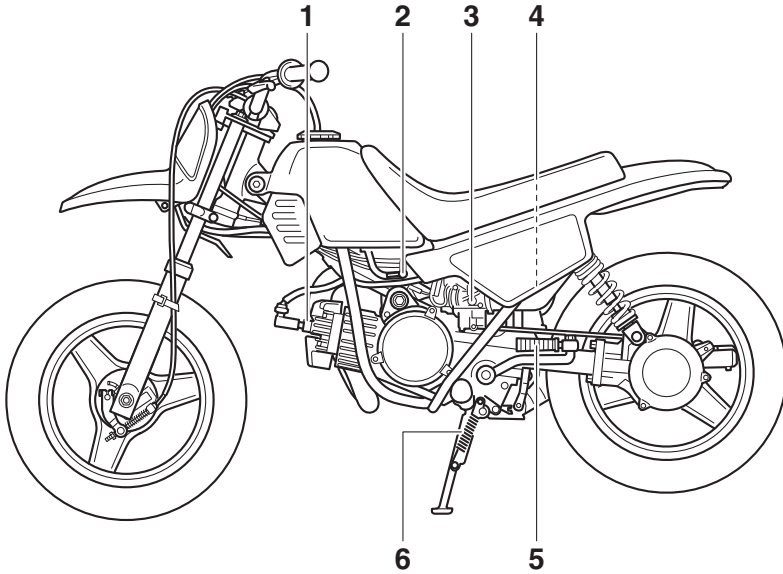

1. Spark plug (page 7-6)
2. Fuel cock (page 4-6)
3. Throttle stop screw (page 7-13)
4. Air filter element (page 7-10)
5. Kickstarter (page 4-7)
6. Centerstand (page 7-21)



## Right view

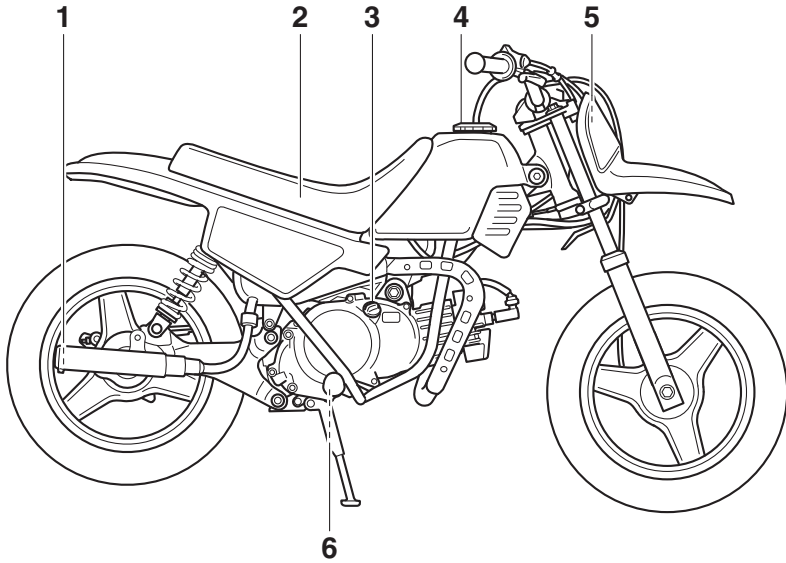

1. Spark arrester (page 7-11)
2. Seat (page 4-8)
3. Transmission oil filler cap (page 7-8)
4. Fuel tank cap (page 4-3)
5. 2-stroke engine oil tank cap (page 4-6)
6. Transmission oil drain bolt (page 7-8)

# Description

---

EAU63401

## Controls and instruments

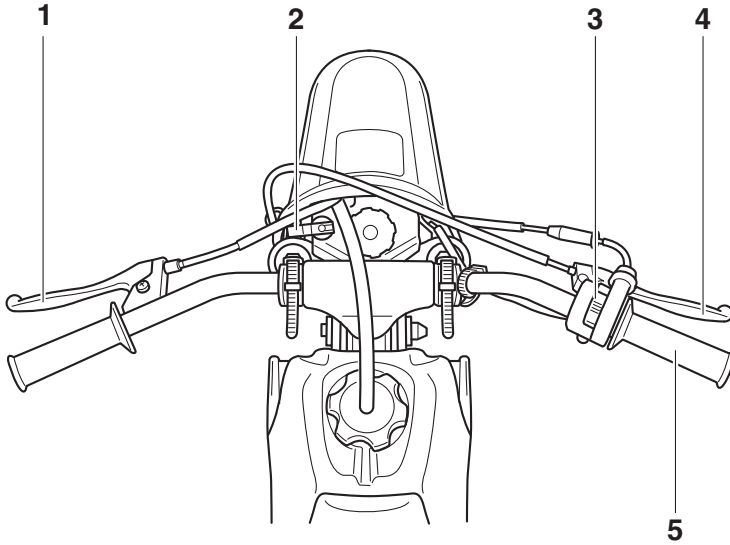

1. Rear brake lever (page 4-3)
2. Starter (choke) lever (page 4-7)
3. Engine stop switch (page 4-1)
4. Front brake lever (page 4-2)
5. Throttle grip (page 7-14)

## Handlebar switch

EAU40661

EAU41045

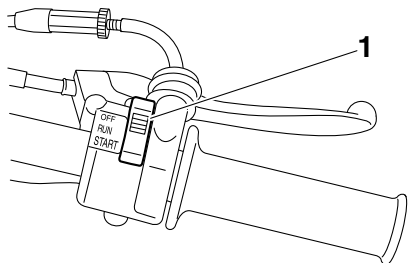

1. Engine stop switch “OFF/RUN/START”

## Engine stop switch “OFF/RUN/START”

EAU40675

Set this switch to “START” before starting the engine. Set this switch to “RUN” after warming up the engine or before starting off. Set this switch to “OFF” to stop the engine.

### TIP

- The engine cannot be started with this switch set to the “RUN” position.
- The engine speed is limited while this switch is set to the “START” position, therefore the motorcycle cannot be ridden in that switch position.

## Speed limiter and power reduction plate

Your motorcycle is equipped with an adjustable speed limiter and a power reduction plate. The speed limiter keeps the throttle from fully opening, even when the throttle grip is turned to the maximum. The power reduction plate is installed in the exhaust manifold to limit the amount of power available while learning.

### Speed limiter

1. Loosen the locknut.
2. To increase the maximum engine power available and the maximum speed of the motorcycle, turn the adjusting screw in direction (a). To decrease the maximum engine power available and the maximum speed of the motorcycle, turn the adjusting screw in direction (b).

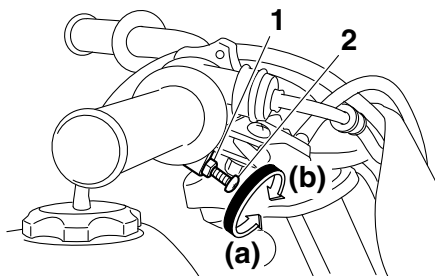

1. Locknut
2. Adjusting screw
3. Tighten the locknut.

# Instrument and control functions

EAU12902

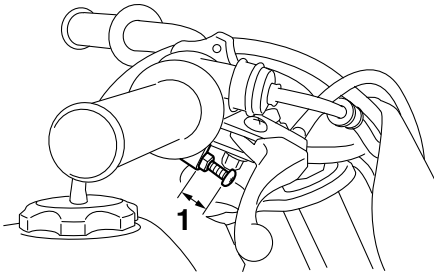

1. No more than 7 mm (0.28 in)

## TIP

4 The adjusting range of the speed limiter screw is from the fully turned-in position to 7 mm (0.28 in) turned out. When the screw is turned out to 7 mm (0.28 in), the throttle grip can only be opened approximately halfway. If more power is required, please consult a Yamaha dealer.

EWA14632

## ! WARNING

Improper adjustment of the speed limiter could cause improper throttle operation. You could lose control, have an accident or be injured. Do not turn the adjusting screw out more than 7 mm (0.28 in) before consulting a Yamaha dealer. Always make sure the throttle grip free play is adjusted to 1.5–3.5 mm (0.06–0.14 in). (See page 7-14.)

## Power reduction plate

Once the rider can operate with skill at the top speed permitted by adjusting the speed limiter alone, the power reduction plate can be removed. (See page 7-7.)

## Front brake lever

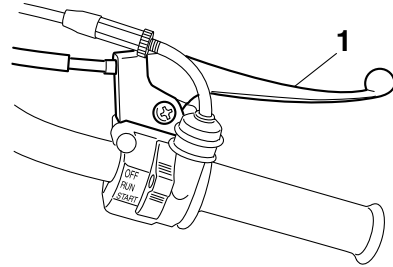

1. Front brake lever

The front brake lever is located on the right side of the handlebar. To apply the front brake, pull this lever toward the throttle grip.

## Rear brake lever

EAU12952

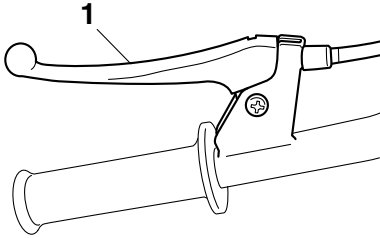

1. Rear brake lever

The rear brake lever is located on the left side of the handlebar. To apply the rear brake, pull this lever toward the handlebar grip.

## Fuel tank cap

EAU13183

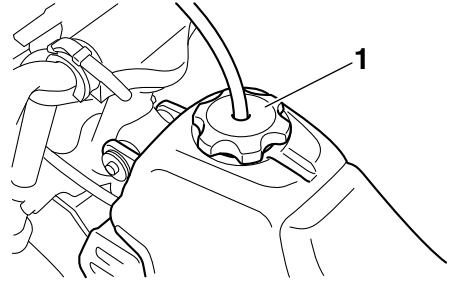

1. Fuel tank cap

To remove the fuel tank cap, turn it counterclockwise, and then pull it off. To install the fuel tank cap, insert it into the tank opening, and then turn it clockwise.

4

EWA11092

### **WARNING**

**Make sure that the fuel tank cap is properly closed after filling fuel. Leaking fuel is a fire hazard.**

# Instrument and control functions

## Fuel

EAU13213

Make sure there is sufficient gasoline in the tank.

EWA10882

### **WARNING**

Gasoline and gasoline vapors are extremely flammable. To avoid fires and explosions and to reduce the risk of injury when refueling, follow these instructions.

1. Before refueling, turn off the engine and be sure that no one is sitting on the vehicle. Never refuel while smoking, or while in the vicinity of sparks, open flames, or other sources of ignition such as the pilot lights of water heaters and clothes dryers.
2. Do not overfill the fuel tank. Stop filling when the fuel reaches the bottom of the filler tube. Because fuel expands when it heats up, heat from the engine or the sun can cause fuel to spill out of the fuel tank.

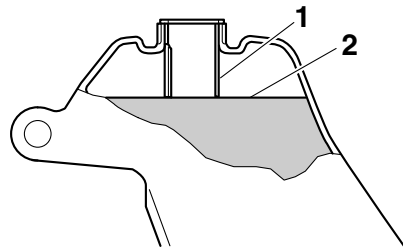

1. Fuel tank filler tube
2. Maximum fuel level

3. Wipe up any spilled fuel immediately. **NOTICE: Immediately wipe off spilled fuel with a clean,**

dry, soft cloth, since fuel may deteriorate painted surfaces or plastic parts. [ECA10072]

4. Be sure to securely close the fuel tank cap.

EWA15152

### **WARNING**

Gasoline is poisonous and can cause injury or death. Handle gasoline with care. Never siphon gasoline by mouth. If you should swallow some gasoline or inhale a lot of gasoline vapor, or get some gasoline in your eyes, see your doctor immediately. If gasoline spills on your skin, wash with soap and water. If gasoline spills on your clothing, change your clothes.

EAU41987

#### **Recommended fuel:**

REGULAR UNLEADED GASOLINE ONLY

#### **Fuel tank capacity:**

2.0 L (0.5 US gal, 0.4 Imp.gal)

ECA15591

### **NOTICE**

Use only unleaded gasoline. The use of leaded gasoline will cause severe damage to internal engine parts, such as the piston rings as well as to the exhaust system.

- For Canada: Use gasoline with a pump octane number  $[(R+M)/2]$  of 86 or higher (research octane number of 91 or higher).
- For Oceania and South Africa: Use gasoline with a research octane number of 91 or higher.

# Instrument and control functions

EAU13414

- For Europe: Use gasoline with a research octane number of 95 or higher.

If knocking (or pinging) occurs, use a gasoline of a different brand or premium unleaded fuel. Use of unleaded fuel will extend spark plug life and reduce maintenance costs.

## Gasohol

There are two types of gasohol: gasohol containing ethanol and that containing methanol. Gasohol containing ethanol can be used if ethanol content does not exceed 10% (E10). Gasohol containing methanol is not recommended by Yamaha because it can cause damage to the fuel system or vehicle performance problems.

## For Europe



## TIP

- This mark identifies the recommended fuel for this vehicle as specified by European regulation (EN228).
- Confirm the gasoline nozzle has the same mark when fueling.

## Fuel tank breather hose

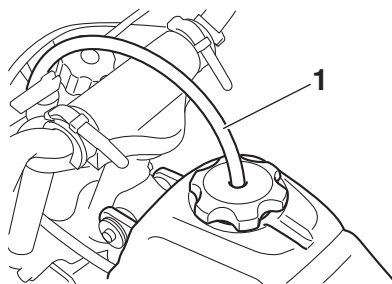

1. Fuel tank breather hose

Before operating the motorcycle:

- Check the fuel tank breather hose connection.
- Check the fuel tank breather hose for cracks or damage, and replace it if necessary.
- Make sure that the fuel tank breather hose is not blocked, and clean it if necessary.

# Instrument and control functions

EAU13454

EAU40702

## 2-stroke engine oil

Make sure that there is sufficient 2-stroke engine oil in the oil tank. Add the recommended 2-stroke engine oil as necessary.

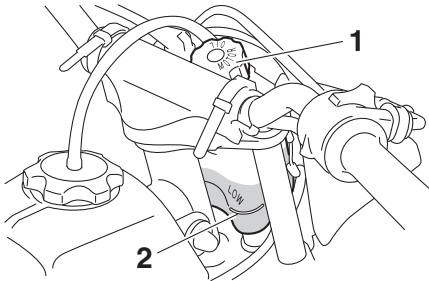

1. 2-stroke engine oil tank cap
2. Minimum level mark

### Recommended oil:

See page 9-1.

### Oil quantity:

0.30 L (0.32 US qt, 0.26 Imp.qt)

ECA16671

### NOTICE

**Make sure that the 2-stroke engine oil tank cap is properly installed.**

## Fuel cock

The fuel cock supplies fuel from the tank to the carburetor while filtering it also.

The fuel cock has two positions:

### S (stop)

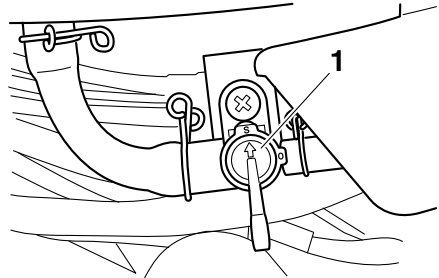

1. Arrow mark pointing to "S" (stop)

With the lever in this position, fuel will not flow. Always return the lever to this position when the engine is not running.

### O (on)

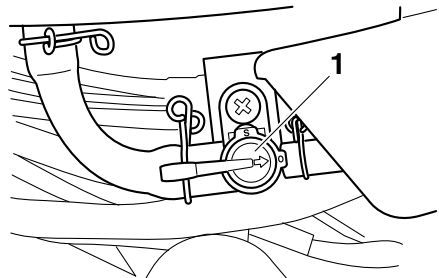

1. Arrow mark pointing to "O" (on)

With the lever in this position, fuel flows to the carburetor. Normal riding is done with the lever in this position.



## Starter (choke) lever “”

EAU13591

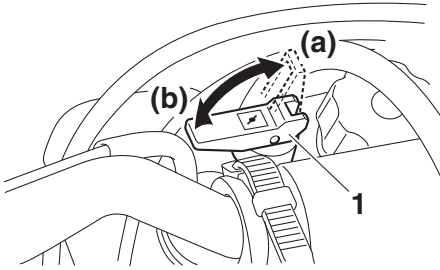

1. Starter (choke) lever “”

Starting a cold engine requires a richer air-fuel mixture, which is supplied by the starter (choke).

Move the lever in direction (a) to turn on the starter (choke).

Move the lever in direction (b) to turn off the starter (choke).

## Kickstarter

EAU13681

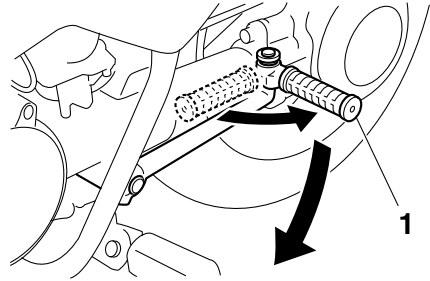

1. Kickstarter

To start the engine, fold out the kickstarter lever, move it down lightly with your foot until the gears engage, and then push it down smoothly but forcefully.

# Instrument and control functions

## Seat

EAU40921

### TIP

Make sure that the seat is properly secured before riding.

### To remove the seat

1. Remove the mudguard by removing the bolts and washers.

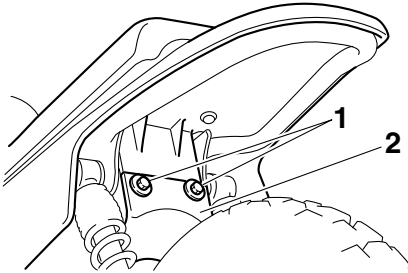

1. Bolt and washer
2. Mudguard

2. Pull the seat off.

### To install the seat

1. Insert the projection on the front of the seat into the seat holder as shown.

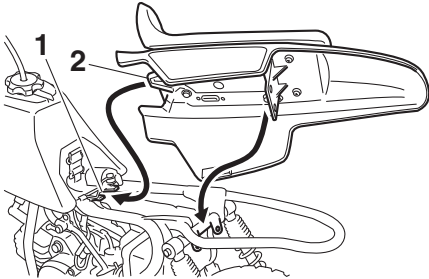

1. Seat holder
2. Projection

2. Place the seat in the original position.
3. Install the mudguard by installing the washers and bolts.

# Instrument and control functions

## Cable lock (for Europe)

EAU53762

Your motorcycle came with an external anti-theft device to help prevent unauthorized use. Please locate the cable and lock assembly that came with your motorcycle.

EWA16301

### **WARNING**

**Properly stow the cable and lock assembly inside a bag or other secure location before operating your motorcycle. Do not hang your cable lock from anywhere on the motorcycle or your person! It may become entangled with the wheels, handlebars, or other parts of the motorcycle, causing loss of control and possibly an accident.**

## To lock your motorcycle

1. Park your motorcycle in the desired location.
2. Make sure that the motorcycle is securely parked. Use the side-stand/centerstand or other support.
3. Disconnect the cable from the lock assembly.
4. Route one end of the cable through the rear wheel, and then insert both ends of the cable into the lock assembly and lock it.

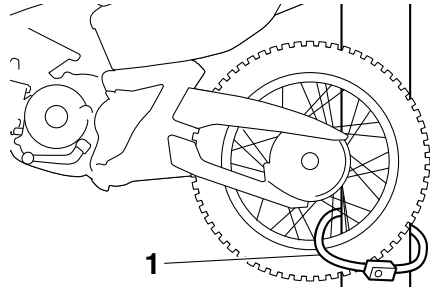

1. Correct cable and lock assembly use

5. Perform the above steps in reverse order before riding your motorcycle.

# For your safety – pre-operation checks

EAU63440

Inspect your vehicle each time you use it to make sure the vehicle is in safe operating condition. Always follow the inspection and maintenance procedures and schedules described in the Owner's Manual.

EWA11152

## **WARNING**

**Failure to inspect or maintain the vehicle properly increases the possibility of an accident or equipment damage. Do not operate the vehicle if you find any problem. If a problem cannot be corrected by the procedures provided in this manual, have the vehicle inspected by a Yamaha dealer.**

Before using this vehicle, check the following points:

ITEM	CHECKS	PAGE
<b>Fuel</b>	<ul style="list-style-type: none"><li>• Check fuel level in fuel tank.</li><li>• Refuel if necessary.</li><li>• Check fuel line for leakage.</li><li>• Check fuel tank breather hose for obstructions, cracks or damage, and check hose connection.</li></ul>	4-4, 4-5
<b>2-stroke engine oil</b>	<ul style="list-style-type: none"><li>• Check oil level in oil tank.</li><li>• If necessary, add recommended oil to specified level.</li><li>• Check vehicle for oil leakage.</li></ul>	4-6
<b>Transmission oil</b>	<ul style="list-style-type: none"><li>• Check oil level in transmission case.</li><li>• If necessary, add recommended oil to specified level.</li><li>• Check for leakage.</li></ul>	7-8
<b>Middle and final gear cases</b>	<ul style="list-style-type: none"><li>• Check vehicle for grease leakage.</li></ul>	7-10
<b>Front brake</b>	<ul style="list-style-type: none"><li>• Check operation.</li><li>• Lubricate cable if necessary.</li><li>• Check lever free play.</li><li>• Adjust if necessary.</li></ul>	7-17, 7-18
<b>Rear brake</b>	<ul style="list-style-type: none"><li>• Check operation.</li><li>• Lubricate cable if necessary.</li><li>• Check lever free play.</li><li>• Adjust if necessary.</li></ul>	7-17, 7-18
<b>Throttle grip</b>	<ul style="list-style-type: none"><li>• Make sure that operation is smooth.</li><li>• Check throttle grip free play.</li><li>• If necessary, have Yamaha dealer adjust throttle grip free play and lubricate cable and grip housing.</li></ul>	7-14, 7-19
<b>Control cables</b>	<ul style="list-style-type: none"><li>• Make sure that operation is smooth.</li><li>• Lubricate if necessary.</li></ul>	7-19
<b>Wheels and tires</b>	<ul style="list-style-type: none"><li>• Check for damage.</li><li>• Check tire condition and tread depth.</li><li>• Check air pressure.</li><li>• Correct if necessary.</li></ul>	7-14, 7-16
<b>Brake levers</b>	<ul style="list-style-type: none"><li>• Make sure that operation is smooth.</li><li>• Lubricate lever pivoting points if necessary.</li></ul>	7-20

# For your safety – pre-operation checks

---

ITEM	CHECKS	PAGE
<b>Centerstand</b>	<ul style="list-style-type: none"><li>• Make sure that operation is smooth.</li><li>• Lubricate pivot if necessary.</li></ul>	7-21
<b>Chassis fasteners</b>	<ul style="list-style-type: none"><li>• Make sure that all nuts, bolts and screws are properly tightened.</li><li>• Tighten if necessary.</li></ul>	—
<b>Engine stop switch</b>	<ul style="list-style-type: none"><li>• Check operation.</li></ul>	4-1

# Operation and important riding points

---

EAU15952

EAU4088B

Read the Owner's Manual carefully to become familiar with all controls. If there is a control or function you do not understand, ask your Yamaha dealer.

EWA10272

## **WARNING**

**Failure to familiarize yourself with the controls can lead to loss of control, which could cause an accident or injury.**

---

## **Starting and warming up a cold engine**

1. Turn the fuel cock lever to "O" (on).
2. Set the engine stop switch to "START".
3. Turn the starter (choke) on and completely close the throttle. (See page 4-7.)
4. While applying the front or rear brake, start the engine by pushing the kickstarter lever down.
5. When the engine is warm, turn the starter (choke) off and set the engine stop switch to "RUN".

## **TIP**

The engine is warm when it responds quickly to the throttle with the starter (choke) turned off.

---

ECA11043

## **NOTICE**

**For maximum engine life, never accelerate hard when the engine is cold!**

---

# Operation and important riding points

---

EAU16661

## Starting a warm engine

Follow the same procedure as for starting a cold engine with the exception that the starter (choke) is not required when the engine is warm. Instead, start the engine with the throttle slightly open.

### **TIP** \_\_\_\_\_

If the engine does not start after several kicks, try again with the throttle 1/4 to 1/2 open.

---

EAU41004

## Starting off

1. While applying the rear brake lever, push the motorcycle off the centerstand.
2. Completely close the throttle.
3. Set the engine stop switch to "RUN".
4. Check for oncoming off-road vehicles, release the rear brake lever, and then slowly turn the throttle grip in order to take off.

# Operation and important riding points

## Acceleration and deceleration

EAU16782

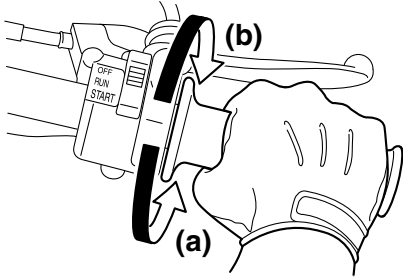

The speed can be adjusted by opening and closing the throttle. To increase the speed, turn the throttle grip in direction (a). To reduce the speed, turn the throttle grip in direction (b).

## Braking

EAU41013

EWA14572

### **WARNING**

- Avoid braking hard or suddenly (especially when leaning over to one side), otherwise the motorcycle may skid or overturn.
- Keep in mind that braking on wet surfaces is much more difficult.
- Ride slowly down a hill, as braking downhill can be very difficult.

1. Close the throttle completely.
2. Apply both front and rear brakes simultaneously while gradually increasing the pressure.

### Front

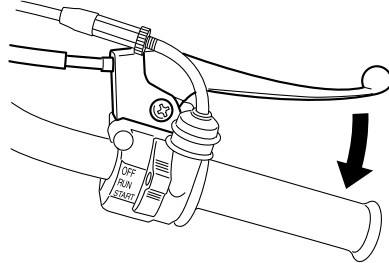

### Rear

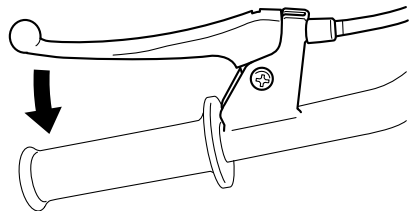



# Operation and important riding points

---

EAU42031

EAU40723

## Engine break-in

There is never a more important period in the life of your engine than the first 5 hours of riding. It is also important to accustom the rider to the motorcycle during this time. Please read the following information carefully.

Since the engine is brand new, do not put an excessive load on it for the first 5 hours of operation. The various parts in the engine wear and polish themselves to the correct operating clearances. During this period, prolonged full-throttle operation or any condition that might result in engine overheating must be avoided. However, momentary full-throttle operation under load (i.e., two to three seconds maximum) does not harm the engine. Each full-throttle acceleration should be followed with a substantial rest period for the engine. To allow the engine to cool down from the temporary buildup of heat, cruise at a lower engine speed.

After the first 5 hours of operation, thoroughly check the motorcycle for loose parts, oil leakage and any other problems. Be sure to inspect and make adjustments thoroughly, especially cables. In addition, check all fittings and fasteners for looseness, and tighten if necessary.

ECA10271

### **NOTICE**

---

**If any engine trouble should occur during the engine break-in period, immediately have a Yamaha dealer check the vehicle.**

---

## Parking

When parking, stop the engine, and then turn the fuel cock lever to “S” (stop).

EWA10312

### **WARNING**

---

- **Since the engine and exhaust system can become very hot, park in a place where pedestrians or children are not likely to touch them and be burned.**
  - **Do not park on a slope or on soft ground, otherwise the vehicle may overturn, increasing the risk of a fuel leak and fire.**
  - **Do not park near grass or other flammable materials which might catch fire.**
-

# Periodic maintenance and adjustment

---

EAU17246

Periodic inspection, adjustment, and lubrication will keep your vehicle in the safest and most efficient condition possible. Safety is an obligation of the vehicle owner/operator. The most important points of vehicle inspection, adjustment, and lubrication are explained on the following pages.

The intervals given in the periodic maintenance charts should be simply considered as a general guide under normal riding conditions. However, depending on the weather, terrain, geographical location, and individual use, the maintenance intervals may need to be shortened.

EWA10322

## **WARNING**

**Failure to properly maintain the vehicle or performing maintenance activities incorrectly may increase your risk of injury or death during service or while using the vehicle. If you are not familiar with vehicle service, have a Yamaha dealer perform service.**

EWA15123

## **WARNING**

**Turn off the engine when performing maintenance unless otherwise specified.**

- **A running engine has moving parts that can catch on body parts or clothing and electrical parts that can cause shocks or fires.**
- **Running the engine while servicing can lead to eye injury, burns, fire, or carbon monoxide poisoning – possibly leading to**

**death. See page 2-2 for more information about carbon monoxide.**

EWA15461

## **WARNING**

**Brake discs, calipers, drums, and linings can become very hot during use. To avoid possible burns, let brake components cool before touching them.**

# Periodic maintenance and adjustment

---

EAU17303

EAU17312

Emission controls not only function to ensure cleaner air, but are also vital to proper engine operation and maximum performance. In the following periodic maintenance charts, the services related to emissions control are grouped separately. These services require specialized data, knowledge, and equipment. Maintenance, replacement, or repair of the emission control devices and systems may be performed by any repair establishment or individual that is certified (if applicable). Yamaha dealers are trained and equipped to perform these particular services.

## Owner's tool kit

The service information included in this manual and the tools provided in the owner's tool kit are intended to assist you in the performance of preventive maintenance and minor repairs. However, additional tools such as a torque wrench may be necessary to perform certain maintenance work correctly.

### **TIP**

---

If you do not have the tools or experience required for a particular job, have a Yamaha dealer perform it for you.

---

# Periodic maintenance and adjustment

EAU69180

## Periodic maintenance chart for the emission control system

### TIP

Items marked with an asterisk should be performed by a Yamaha dealer as they require special tools, data and technical skills.

NO.	ITEM	CHECK OR MAINTENANCE JOB	INITIAL			THEREAFTER EVERY	
			1 month	3 months	6 months	6 months	12 months
1	* Fuel line	<ul style="list-style-type: none"> <li>• Check fuel hoses for cracks or damage.</li> <li>• Replace if necessary.</li> </ul>	√	√	√	√	
2	Spark plug	<ul style="list-style-type: none"> <li>• Check condition.</li> <li>• Adjust gap and clean.</li> <li>• Replace if necessary.</li> </ul>	√	√	√	√	
3	Air filter element	<ul style="list-style-type: none"> <li>• Clean with solvent.</li> <li>• Replace if necessary.</li> </ul>		√	√	√	
4	* Carburetor	<ul style="list-style-type: none"> <li>• Check engine idling speed and starter operation.</li> </ul>		√	√	√	
		<ul style="list-style-type: none"> <li>• Adjust if necessary.</li> <li>• Clean.</li> </ul>			√		√
5	* Cylinder head and exhaust system	<ul style="list-style-type: none"> <li>• Check for leakage.</li> <li>• Tighten if necessary.</li> <li>• Decarbonize if necessary.</li> </ul>		√	√	√	
6	* Spark arrester	<ul style="list-style-type: none"> <li>• Clean.</li> </ul>			√	√	

# Periodic maintenance and adjustment

EAU69202

## General maintenance and lubrication chart

### TIP

Items marked with an asterisk should be performed by a Yamaha dealer as they require special tools, data and technical skills.

NO.	ITEM	CHECK OR MAINTENANCE JOB	INITIAL			THEREAFTER EVERY	
			1 month	3 months	6 months	6 months	12 months
1	*	<b>Front brake</b>	√	√	√	√	
		<ul style="list-style-type: none"> <li>• Check operation.</li> <li>• Adjust brake lever free play.</li> <li>• Replace brake shoes.</li> </ul>					
2	*	<b>Rear brake</b>	√	√	√	√	
		<ul style="list-style-type: none"> <li>• Check operation.</li> <li>• Adjust brake lever free play.</li> <li>• Replace brake shoes.</li> </ul>					
3	*	<b>Wheels</b>	√	√	√	√	
4	*	<b>Tires</b>	√	√	√	√	
5	*	<b>Wheel bearings</b>					√
6	*	<b>Steering bearings</b>			√		√
		<ul style="list-style-type: none"> <li>• Check bearing assemblies for looseness.</li> <li>• Moderately repack with lithium-soap-based grease.</li> </ul>	Every 2 years				
7	*	<b>Middle and final gear cases</b>	√	√	√	√	
		<ul style="list-style-type: none"> <li>• Check for grease leakage.</li> <li>• Check gears for damage and wear.</li> <li>• Lubricate gears with lithium-soap-based grease.</li> </ul>	Every 2 years				
8	*	<b>Chassis fasteners</b>	√	√	√	√	
9	*	<b>Autolube pump</b>	√	√	√	√	
10	*	<b>Transmission oil</b>	√	√	√	√	
		<ul style="list-style-type: none"> <li>• Check for oil leakage.</li> <li>• Correct if necessary.</li> <li>• Change.</li> </ul>	√		√		√

# Periodic maintenance and adjustment

NO.	ITEM	CHECK OR MAINTENANCE JOB	INITIAL			THEREAFTER EVERY	
			1 month	3 months	6 months	6 months	12 months
11	* Front and rear brake lever pivot	<ul style="list-style-type: none"> <li>Apply lithium-soap-based grease lightly.</li> </ul>		√	√	√	
12	* Centerstand pivot	<ul style="list-style-type: none"> <li>Check operation.</li> <li>Apply lithium-soap-based grease lightly.</li> </ul>		√	√	√	
13	* Shock absorber assemblies	<ul style="list-style-type: none"> <li>Check operation and for oil leakage.</li> <li>Replace if necessary.</li> </ul>	√	√	√	√	
14	* Control cables	<ul style="list-style-type: none"> <li>Apply Yamaha cable lubricant or other suitable cable lubricant.</li> </ul>		√	√		√
15	* Throttle grip	<ul style="list-style-type: none"> <li>Check operation.</li> <li>Check throttle grip free play, and adjust if necessary.</li> <li>Apply Yamaha cable lubricant or other suitable cable lubricant.</li> </ul>	√	√	√	√	

7

## TIP

The air filter needs more frequent service if you are riding in unusually wet or dusty areas.

# Periodic maintenance and adjustment

EAU19607

## Checking the spark plug

The spark plug is an important engine component, which is easy to check. Since heat and deposits will cause any spark plug to slowly erode, the spark plug should be removed and checked in accordance with the periodic maintenance and lubrication chart. In addition, the condition of the spark plug can reveal the condition of the engine.

### To remove the spark plug

1. Remove the spark plug cap.

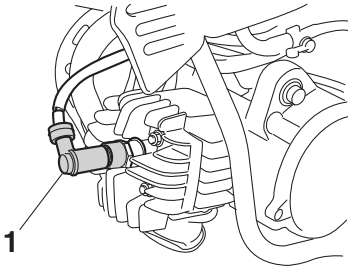

1. Spark plug cap

2. Remove the spark plug as shown, with the spark plug wrench included in the owner's tool kit.

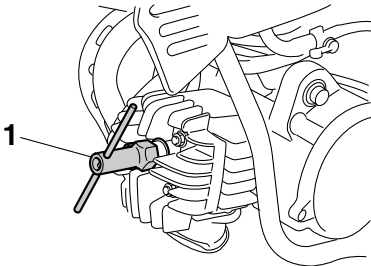

1. Spark plug wrench

### To check the spark plug

1. Check that the porcelain insulator around the center electrode of the spark plug is a medium-to-light tan (the ideal color when the vehicle is ridden normally).

### TIP

If the spark plug shows a distinctly different color, the engine could be operating improperly. Do not attempt to diagnose such problems yourself. Instead, have a Yamaha dealer check the vehicle.

2. Check the spark plug for electrode erosion and excessive carbon or other deposits, and replace it if necessary.

**Specified spark plug:**  
NGK/BPR4HS

3. Measure the spark plug gap with a wire thickness gauge and, if necessary, adjust the gap to specification.

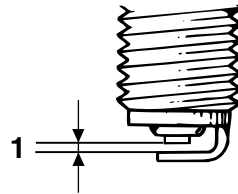

1. Spark plug gap

**Spark plug gap:**  
0.6–0.7 mm (0.024–0.028 in)

# Periodic maintenance and adjustment

EAU41104

## To install the spark plug

1. Clean the surface of the spark plug gasket and its mating surface, and then wipe off any grime from the spark plug threads.
2. Install the spark plug with the spark plug wrench, and then tighten it to the specified torque.

### Tightening torque:

Spark plug:  
20 N·m (2.0 kgf·m, 15 lb·ft)

## TIP

If a torque wrench is not available when installing a spark plug, a good estimate of the correct torque is 1/4–1/2 turn past finger tight. However, the spark plug should be tightened to the specified torque as soon as possible.

3. Install the spark plug cap.

## Removing the power reduction plate

To obtain full engine performance capability, removing the power reduction plate is required.

1. Remove the exhaust manifold by removing the bolts. **WARNING! Always let the exhaust system cool prior to touching exhaust components.** [EWA14582]

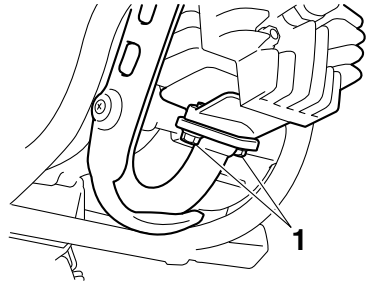

1. Exhaust manifold bolt

2. Remove the gasket.
3. Remove the power reduction plate.

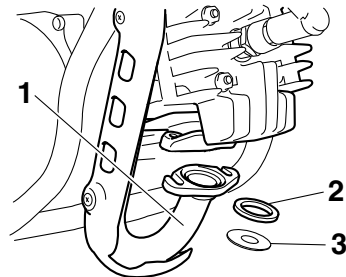

1. Exhaust manifold
2. Gasket
3. Power reduction plate



# Periodic maintenance and adjustment

EAU40896

## TIP

Store the power reduction plate with the Owner's Manual so that it is readily available whenever you want to reduce the engine power.

4. Install the exhaust manifold and its new gasket by installing the bolts, and then tighten the bolts to the specified torque.

### Tightening torque:

Exhaust manifold bolt:  
9 N·m (0.9 kgf·m, 6.6 lb·ft)

## Transmission oil

The transmission must be checked for oil leakage before each ride. If any leakage is found, have a Yamaha dealer check and repair the motorcycle. In addition, the transmission oil must be changed at the intervals specified in the periodic maintenance and lubrication chart.

### To change the transmission oil

1. Place the motorcycle on the centerstand.
2. Place an oil pan under the transmission to collect the used oil.
3. Remove the transmission oil filler cap, the transmission oil drain bolt and its gasket to drain the oil from the transmission.

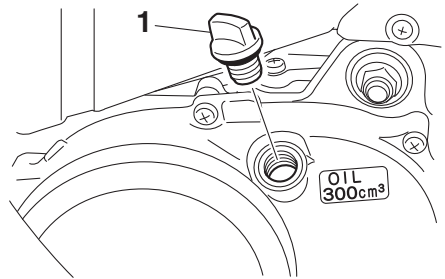

1. Transmission oil filler cap

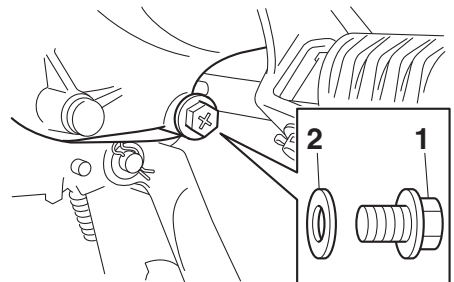

1. Transmission oil drain bolt  
2. Gasket

# Periodic maintenance and adjustment

4. Install the transmission oil drain bolt and its new gasket, and then tighten the bolt to the specified torque.

## Tightening torque:

Transmission oil drain bolt:  
14 N·m (1.4 kgf·m, 10 lb·ft)

5. Refill with the specified amount of the recommended transmission oil.

## Recommended transmission oil:

See page 9-1.

## Oil change quantity:

0.30 L (0.32 US qt, 0.26 Imp.qt)

ECA10453

## NOTICE

- In order to prevent clutch slippage (since the transmission oil also lubricates the clutch), do not mix any chemical additives. Do not use oils with a diesel specification of "CD" or oils of a higher quality than specified. In addition, do not use oils labeled "ENERGY CONSERVING II" or higher.
- Make sure that no foreign material enters the transmission.

6. Check the O-ring for damage, and replace it if necessary.

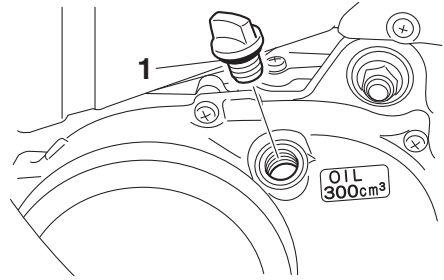

1. O-ring

7. Install and tighten the transmission oil filler cap.
8. Start the engine, and then let it idle for several minutes while checking the transmission for oil leakage. If oil is leaking, immediately turn the engine off and check for the cause.

# Periodic maintenance and adjustment

EAU41712

EAU40904

## Middle and final gear cases

The middle and final gear cases must be checked for grease leakage before each ride. If any leakage is found, have a Yamaha dealer check and repair the motorcycle. In addition, have a Yamaha dealer check and lubricate the middle and final gears at the intervals specified in the periodic maintenance and lubrication chart.

## Cleaning the air filter element

The air filter element should be cleaned at the intervals specified in the periodic maintenance and lubrication chart. Clean or, if necessary, replace the air filter element more frequently if you are riding in unusually wet or dusty areas.

1. Remove the seat. (See page 4-8.)
2. Remove the air filter case cover by removing the screw.

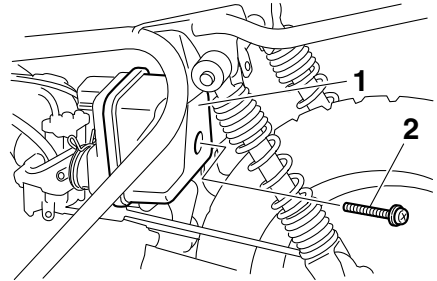

1. Air filter case cover
2. Screw

3. Pull the sponge material out, clean it with solvent, and then squeeze the remaining solvent out.

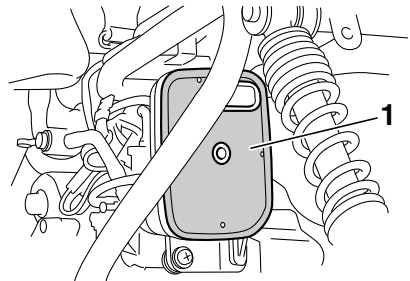

1. Sponge material

# Periodic maintenance and adjustment

EAU41222

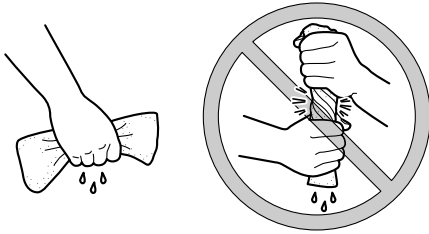

4. Apply oil of the recommended type to the entire surface of the sponge material, and then squeeze the excess oil out.

## TIP

The sponge material should be wet but not dripping.

### Recommended oil:

Yamaha foam air filter oil or other quality foam air filter oil

5. Insert the sponge material into the air filter case. **NOTICE: Make sure that the sponge material is properly seated in the air filter case. The engine should never be operated without the sponge material installed, otherwise the piston(s) and/or cylinder(s) may become excessively worn.**
- [ECA15622]
6. Install the air filter case cover by installing the screw.
  7. Install the seat.

## Cleaning the spark arrester

The spark arrester should be cleaned at the intervals specified in the periodic maintenance and lubrication chart.

EWA10981

### WARNING

- Always let the exhaust system cool prior to touching exhaust components.
- Do not start the engine when cleaning the exhaust system.

1. Remove the tailpipe by removing the screw, and then pulling it out of the muffler.

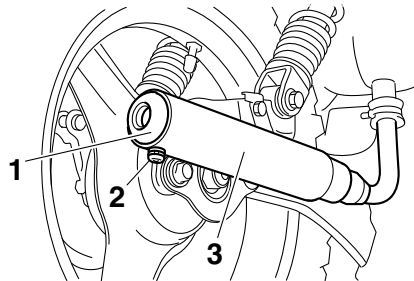

1. Tailpipe
2. Screw
3. Muffler

2. Tap the tailpipe lightly, and then use a wire brush to remove any carbon deposits from the spark arrester portion of the tailpipe and inside of the tailpipe housing.

# Periodic maintenance and adjustment

EAU39931

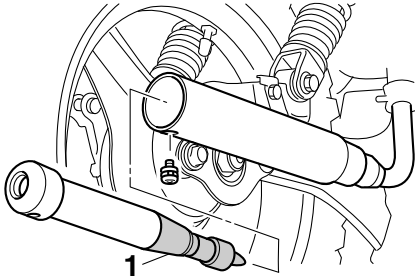

1. Spark arrester

3. Insert the tailpipe into the muffler, and then install and tighten the screw.

## TIP

Make sure to align the screw hole when inserting the tailpipe.

## Adjusting the carburetor

The carburetor is an important part of the engine and requires very sophisticated adjustment. Therefore, most carburetor adjustments should be left to a Yamaha dealer, who has the necessary professional knowledge and experience. The adjustment described in the following section, however, may be serviced by the owner as part of routine maintenance.

ECA10551

## NOTICE

**The carburetor has been set and extensively tested at the Yamaha factory. Changing these settings without sufficient technical knowledge may result in poor performance of or damage to the engine.**

# Periodic maintenance and adjustment

EAU21363

## Adjusting the engine idling speed

The engine idling speed must be checked and, if necessary, adjusted as follows at the intervals specified in the periodic maintenance and lubrication chart.

### TIP

A diagnostic tachometer is needed to make this adjustment.

1. Attach the tachometer to the spark plug lead.
2. Start the engine and warm it up for several minutes at 1000–2000 r/min while occasionally revving it to 4000–5000 r/min.

### TIP

The engine is warm when it quickly responds to the throttle.

3. Check the engine idling speed and, if necessary, adjust it to specification by turning the throttle stop screw. To increase the engine idling speed, turn the screw in direction (a). To decrease the engine idling speed, turn the screw in direction (b).

**Engine idling speed:**  
1650–1750 r/min

### TIP

If the specified idling speed cannot be obtained as described above, have a Yamaha dealer make the adjustment.

7

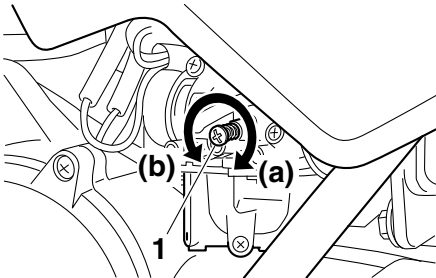

1. Throttle stop screw

# Periodic maintenance and adjustment

EAU21386

EAU64472

## Checking the throttle grip free play

Measure the throttle grip free play as shown.

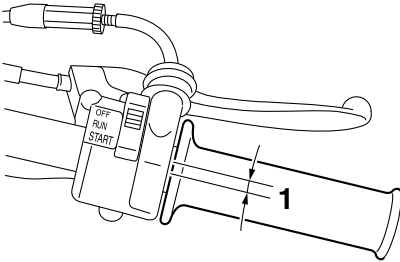

1. Throttle grip free play

**Throttle grip free play:**  
1.5–3.5 mm (0.06–0.14 in)

Periodically check the throttle grip free play and, if necessary, have a Yamaha dealer adjust it.

## Tires

Tires are the only contact between the vehicle and the ground. Safety in all conditions of riding depends on a relatively small area of contact. Therefore, it is essential to maintain the tires in good condition at all times and replace them at the appropriate time with the specified tires.

### Tire air pressure

The tire air pressure should be checked and, if necessary, adjusted before each ride.

EWA15371

### **WARNING**

**Operation of this vehicle with improper tire pressure may cause severe injury or death from loss of control.**

**The tire air pressure must be checked and adjusted on cold tires (i.e., when the temperature of the tires equals the ambient temperature).**

### **Standard tire air pressure:**

Front:  
100 kPa (1.00 kgf/cm<sup>2</sup>, 15 psi)

Rear:  
100 kPa (1.00 kgf/cm<sup>2</sup>, 15 psi)

# Periodic maintenance and adjustment

## Tire inspection

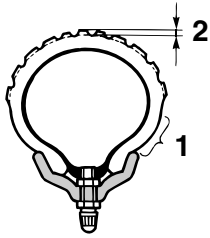

1. Tire sidewall
2. Tire tread depth

The tires must be checked before each ride. If the center tread depth reaches the specified limit, if the tire has a nail or glass fragments in it, or if the sidewall is cracked, have a Yamaha dealer replace the tire immediately.

**Minimum tire tread depth (front and rear):**  
4.0 mm (0.16 in)

## Tire information

This model is equipped with tube tires. Tires age, even if they have not been used or have only been used occasionally. Cracking of the tread and sidewall rubber, sometimes accompanied by carcass deformation, is an evidence of ageing. Old and aged tires shall be checked by tire specialists to ascertain their suitability for further use.

EWA10462

### **! WARNING**

The front and rear tires should be of the same make and design, otherwise the handling characteristics of the vehicle may be different, which could lead to an accident.

After extensive tests, only the tires listed below have been approved for this model by Yamaha.

### Front tire:

Size:  
2.50-10 4PR  
Manufacturer/model:  
BRIDGESTONE/M29  
IRC/Z MARK II (Canada, Oceania, South Africa)

### Rear tire:

Size:  
2.50-10 4PR  
Manufacturer/model:  
BRIDGESTONE/M29  
IRC/Z MARK II (Canada, Oceania, South Africa)

EWA15542

### **! WARNING**

- Have a Yamaha dealer replace excessively worn tires. Operating the motorcycle with excessively worn tires decreases riding stability and can lead to loss of control.
- The replacement of all wheel- and brake-related parts, including the tires, should be left to a Yamaha dealer, who has the necessary professional knowledge and experience.
- It is not recommended to patch a punctured tube. If unavoidable, however, patch the tube very carefully and replace it as soon as possible with a high-quality product.
- Ride conservatively after changing a tire since the tire must seat itself on the rim properly. Failure to allow proper seating may cause tire failure,



# Periodic maintenance and adjustment

---

which may result in damage to the motorcycle and injury to the rider.

---

EAU40782

## Panel wheels

EWA10611

### **WARNING**

**The wheels on this model are not designed for use with tubeless tires. Do not attempt to use tubeless tires on this model.**

---

To maximize the performance, durability, and safe operation of your motorcycle, note the following points regarding the specified wheels.

- The wheel rims should be checked for cracks, bends, warpage or damage before each ride. If any damage is found, have a Yamaha dealer replace the wheel. Do not attempt even the smallest repair to the wheel. A deformed or cracked wheel must be replaced.
- The wheel should be balanced whenever either the tire or wheel has been changed or replaced. An unbalanced wheel can result in poor performance, adverse handling characteristics, and a shortened tire life.

# Periodic maintenance and adjustment

EAU22153

## Adjusting the front and rear brake lever free play

The front and rear brake lever free play should be measured at the positions as shown.

### Front

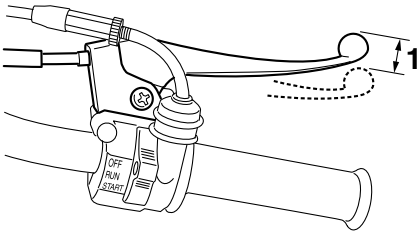

1. Front brake lever free play

### Rear

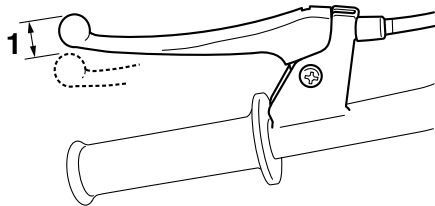

1. Rear brake lever free play

### Front

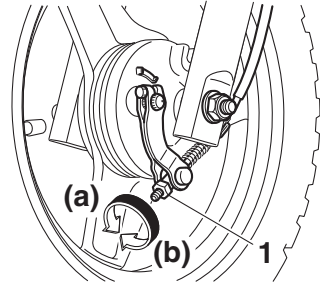

1. Front brake lever free play adjusting nut

### Rear

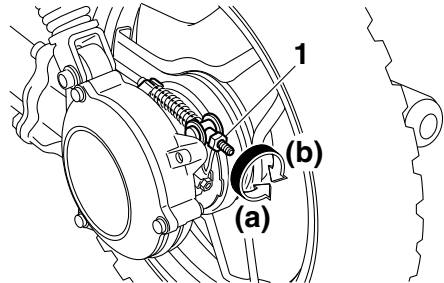

1. Rear brake lever free play adjusting nut

EWA10651

### **WARNING**

**If proper adjustment cannot be obtained as described, have a Yamaha dealer make this adjustment.**

**Front brake lever free play:**  
10.0–20.0 mm (0.39–0.79 in)  
**Rear brake lever free play:**  
10.0–20.0 mm (0.39–0.79 in)

Periodically check the front and rear brake lever free play and, if necessary, adjust them as follows.

To increase the brake lever free play, turn the adjusting nut at the brake shoe plate in direction (a). To decrease the brake lever free play, turn the adjusting nut in direction (b).

# Periodic maintenance and adjustment

EAU41054

## Checking the front and rear brake shoes

The front and rear brake shoes must be checked for wear at the intervals specified in the periodic maintenance and lubrication chart.

### TIP

The wheels must be removed to check brake shoe lining thickness.

- To remove the front wheel: See page 7-23.
- To remove the rear wheel: See page 7-24.

### TIP

Be sure to measure the brake lining at the thinnest portion.

### Front

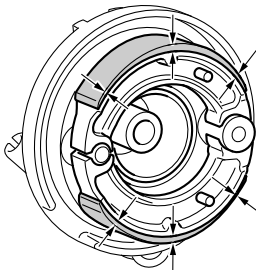

### Rear

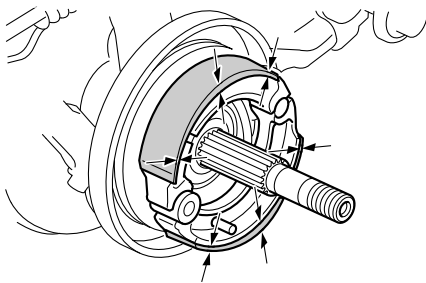

If the lining thickness of a brake shoe is less than 1.5 mm (0.06 in), have a Yamaha dealer replace the brake shoes as a set.

# Periodic maintenance and adjustment

---

EAU23098

## Checking and lubricating the cables

The operation of all control cables and the condition of the cables should be checked before each ride, and the cables and cable ends should be lubricated if necessary. If a cable is damaged or does not move smoothly, have a Yamaha dealer check or replace it. **WARNING! Damage to the outer housing of cables may result in internal rusting and cause interference with cable movement. Replace damaged cables as soon as possible to prevent unsafe conditions.** [EWA10712]

**Recommended lubricant:**

Yamaha cable lubricant or other suitable cable lubricant

EAU23115

## Checking and lubricating the throttle grip and cable

The operation of the throttle grip should be checked before each ride. In addition, the cable should be lubricated by a Yamaha dealer at the intervals specified in the periodic maintenance chart.

The throttle cable is equipped with a rubber cover. Make sure that the cover is securely installed. Even though the cover is installed correctly, it does not completely protect the cable from water entry. Therefore, use care not to pour water directly onto the cover or cable when washing the vehicle. If the cable or cover becomes dirty, wipe clean with a moist cloth.

# Periodic maintenance and adjustment

## Adjusting the Autolube pump

EAU23121

The Autolube pump is a vital and sophisticated component of the engine, which must be adjusted by a Yamaha dealer at the intervals specified in the periodic maintenance and lubrication chart.

## Lubricating the front and rear brake levers

EAU43634

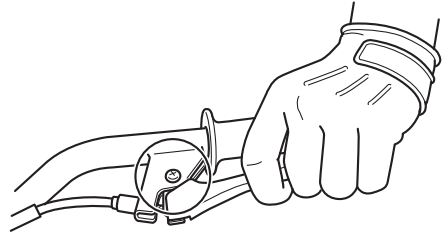

The pivoting points of the front and rear brake levers must be lubricated at the intervals specified in the periodic maintenance and lubrication chart.

**Recommended lubricant:**  
Lithium-soap-based grease

# Periodic maintenance and adjustment

## Checking and lubricating the centerstand

EAU23193

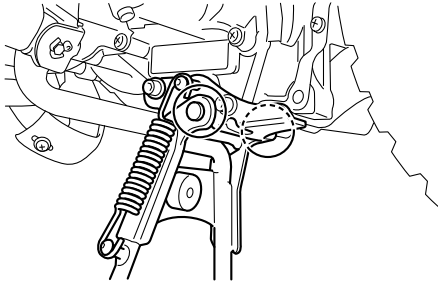

The operation of the centerstand should be checked before each ride, and the pivots and metal-to-metal contact surfaces should be lubricated if necessary.

EWA11302

### **WARNING**

If the centerstand does not move up and down smoothly, have a Yamaha dealer check or repair it. Otherwise, the centerstand could contact the ground and distract the operator, resulting in a possible loss of control.

**Recommended lubricant:**  
Lithium-soap-based grease

## Checking the front fork

EAU23273

The condition and operation of the front fork must be checked as follows at the intervals specified in the periodic maintenance and lubrication chart.

### To check the condition

Check the inner tubes for scratches, damage and excessive oil leakage.

### To check the operation

1. Place the vehicle on a level surface and hold it in an upright position. **WARNING! To avoid injury, securely support the vehicle so there is no danger of it falling over.** [EWA10752]
2. While applying the front brake, push down hard on the handlebars several times to check if the front fork compresses and rebounds smoothly.

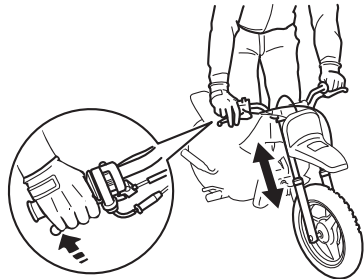

ECA10591

### **NOTICE**

If any damage is found or the front fork does not operate smoothly, have a Yamaha dealer check or repair it.

# Periodic maintenance and adjustment

EAU45512

EAU23292

## Checking the steering

Worn or loose steering bearings may cause danger. Therefore, the operation of the steering must be checked as follows at the intervals specified in the periodic maintenance and lubrication chart.

1. Place the vehicle on the center-stand. **WARNING! To avoid injury, securely support the vehicle so there is no danger of it falling over.** [EWA10752]
2. Hold the lower ends of the front fork legs and try to move them forward and backward. If any free play can be felt, have a Yamaha dealer check or repair the steering.

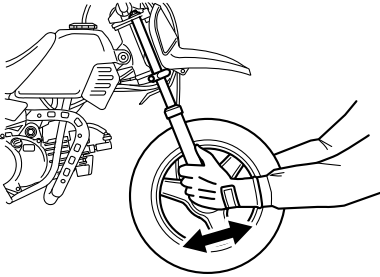

## Checking the wheel bearings

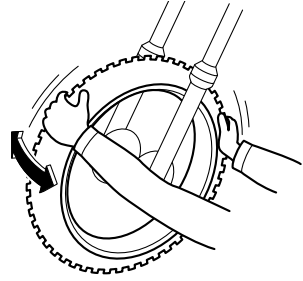

The front and rear wheel bearings must be checked at the intervals specified in the periodic maintenance and lubrication chart. If there is play in the wheel hub or if the wheel does not turn smoothly, have a Yamaha dealer check the wheel bearings.

# Periodic maintenance and adjustment

## Front wheel

EAU24361

EAU56510

EWA10822

### To remove the front wheel

#### **⚠ WARNING**

To avoid injury, securely support the vehicle so there is no danger of it falling over.

1. Place the motorcycle on the centerstand.
2. Disconnect the brake cable at the wheel hub by removing the front brake lever free play adjusting nut, then removing the cable from the brake camshaft lever and brake shoe plate.

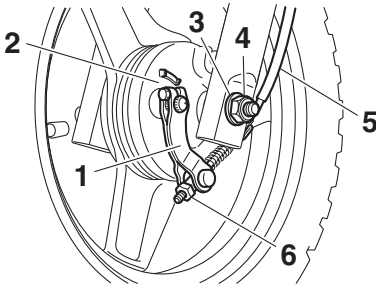

1. Brake camshaft lever
2. Brake shoe plate
3. Washer
4. Axle nut
5. Brake cable
6. Front brake lever free play adjusting nut

3. Remove the axle nut and washer.
4. Pull the wheel axle out, and then remove the wheel.

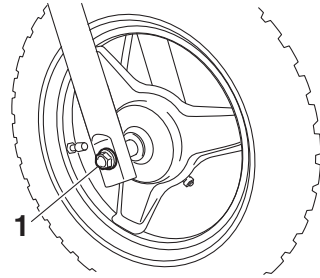

1. Wheel axle

### To install the front wheel

1. Install the brake shoe plate into the wheel hub as shown.

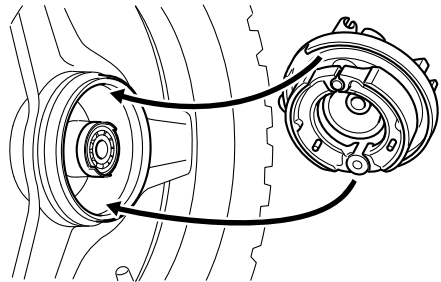

2. Lift the wheel up between the fork legs.

#### **TIP**

Make sure that the slot in the brake shoe plate fits over the retainer on the fork leg.

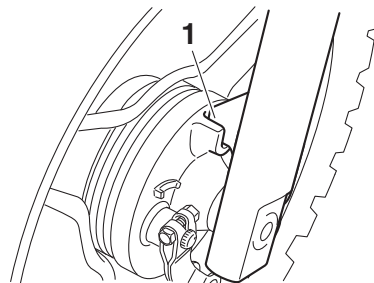

1. Retainer



# Periodic maintenance and adjustment

3. Insert the wheel axle from the right side.
4. Install the washer and axle nut, and then tighten the axle nut to the specified torque.

## Tightening torque:

Axle nut:  
36 N·m (3.6 kgf·m, 27 lb·ft)

5. Connect the brake cable at the wheel hub, and then install the brake lever free play adjusting nut.
6. Adjust the brake lever free play. (See page 7-17.)
7. Take the motorcycle off the centerstand so that the front wheel is on the ground.
8. Push down hard on the handlebar several times to check for proper fork operation.

## Rear wheel

EAU25081

EAU56822

## To remove the rear wheel

EWA10822



**To avoid injury, securely support the vehicle so there is no danger of it falling over.**

1. Place the motorcycle on the centerstand.
  2. Remove the seat. (See page 4-8.)
  3. Remove the muffler bolt and washers. **WARNING! Always let the exhaust system cool prior to touching exhaust components.**
- [EWA14582]
4. Slide the spring clamp down, and then remove the muffler.

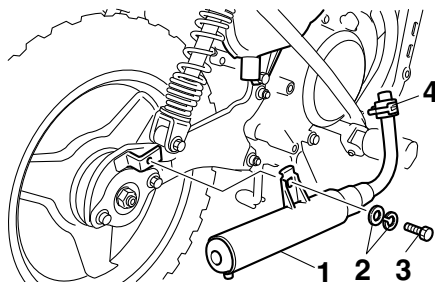

1. Muffler
  2. Washer
  3. Muffler bolt
  4. Spring clamp
5. Remove the exhaust chamber bolt and washers.

# Periodic maintenance and adjustment

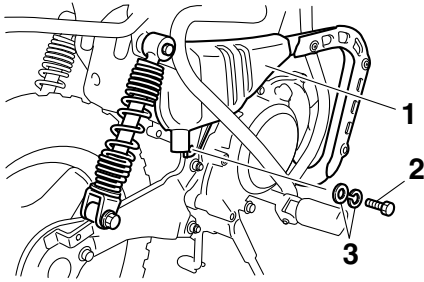

1. Exhaust chamber
2. Exhaust chamber bolt
3. Washer

6. Remove the exhaust manifold bolts, and then remove the exhaust chamber, the power reduction plate and the gasket.

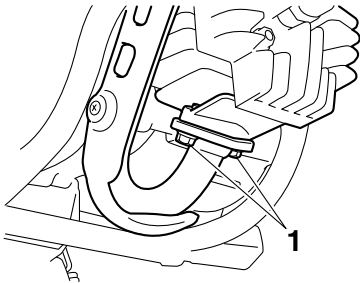

1. Exhaust manifold bolt

7. Remove the right-side rear shock absorber mounting bolt and then tilt the rear shock absorber upward as shown.

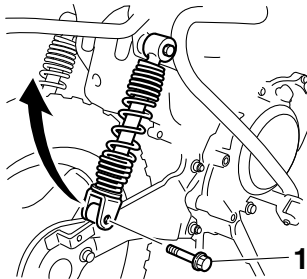

1. Rear shock absorber mounting bolt

8. Remove the axle nut while applying the rear brake.

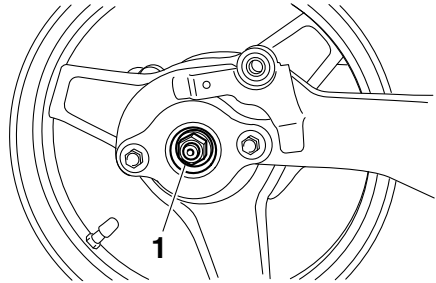

1. Axle nut

9. Remove the rear arm by removing the nuts and washers.

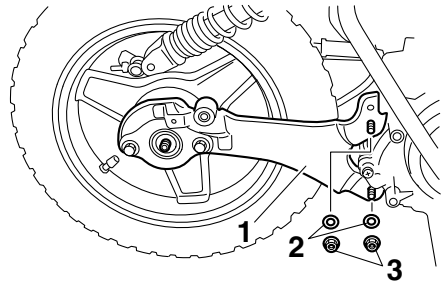

1. Rear arm
2. Washer
3. Rear arm nut

10. Pull the wheel to the right to remove it from the rear axle.

## To install the rear wheel

1. Apply a light coating of lithium-soap-based grease to the splines of the rear axle and wheel hub.
2. Install the wheel to the rear axle.
3. Install the rear arm by installing the washers and nuts.
4. Install the axle nut.
5. Install the right-side rear shock absorber by installing the mounting bolt.

# Periodic maintenance and adjustment

6. While applying the rear brake, tighten the axle nut to the specified torque.
7. Tighten the rear arm nuts and rear shock absorber mounting bolt to the specified torques.

## Tightening torques:

Axle nut:

60 N·m (6.0 kgf·m, 44 lb-ft)

Rear arm nut:

29 N·m (2.9 kgf·m, 21 lb-ft)

Rear shock absorber mounting bolt:

23 N·m (2.3 kgf·m, 17 lb-ft)

8. Install the exhaust chamber by installing the bolt and washers.
9. Install the power reduction plate, a new gasket, and then install the exhaust manifold bolts.

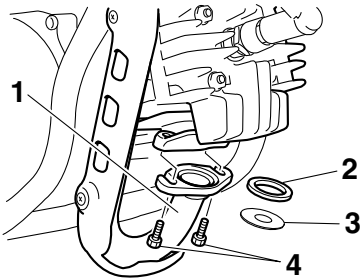

1. Exhaust manifold
2. Gasket
3. Power reduction plate
4. Exhaust manifold bolt

10. Tighten the exhaust manifold bolts and exhaust chamber bolt to the specified torques.

## Tightening torques:

Exhaust manifold bolt:

9 N·m (0.9 kgf·m, 6.6 lb-ft)

Exhaust chamber bolt:

18 N·m (1.8 kgf·m, 13 lb-ft)

11. Install the muffler by sliding the spring clamp up to its original position, and then installing the washers and muffler bolt.

## TIP

Make sure that the spring clamp is positioned with the projection side facing inward.

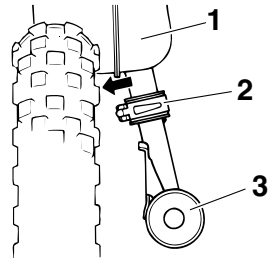

1. Exhaust chamber
2. Spring clamp
3. Muffler

12. Tighten the muffler bolt to the specified torque.

## Tightening torque:

Muffler bolt:

18 N·m (1.8 kgf·m, 13 lb-ft)

13. Adjust the brake lever free play. (See page 7-17.)
14. Install the seat.

# Periodic maintenance and adjustment

---

EAU25853

## Troubleshooting

Although Yamaha motorcycles receive a thorough inspection before shipment from the factory, trouble may occur during operation. Any problem in the fuel, compression, or ignition systems, for example, can cause poor starting and loss of power.

The following troubleshooting chart represents a quick and easy procedure for checking these vital systems yourself. However, should your motorcycle require any repair, take it to a Yamaha dealer, whose skilled technicians have the necessary tools, experience, and know-how to service the motorcycle properly.

Use only genuine Yamaha replacement parts. Imitation parts may look like Yamaha parts, but they are often inferior, have a shorter service life and can lead to expensive repair bills.

EWA15142

### **WARNING**

---

**When checking the fuel system, do not smoke, and make sure there are no open flames or sparks in the area, including pilot lights from water heaters or furnaces. Gasoline or gasoline vapors can ignite or explode, causing severe injury or property damage.**

---

# Periodic maintenance and adjustment

EAU68120

## Troubleshooting chart

### 1. Fuel

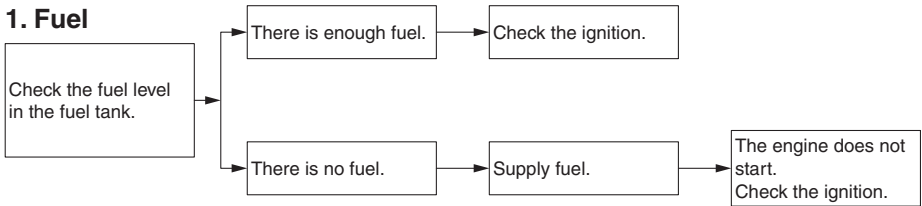

### 2. Ignition

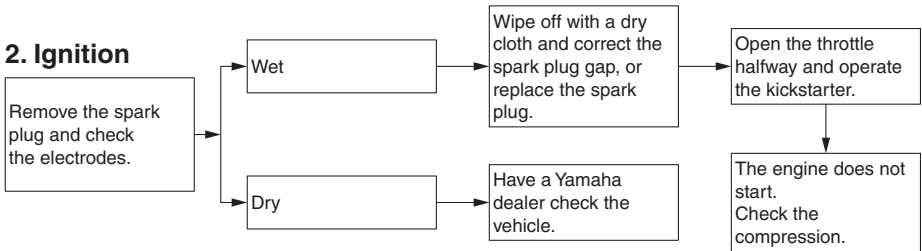

### 3. Compression

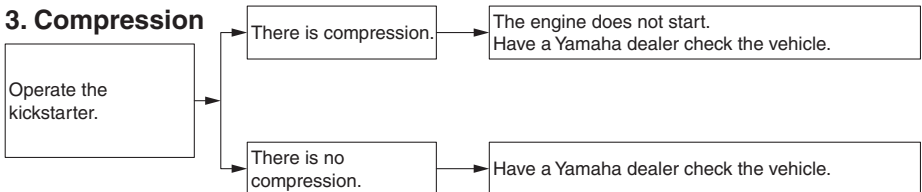

# Motorcycle care and storage

---

## Matte color caution

EAU37834

EAU40636

### **NOTICE**

---

ECA15193

Some models are equipped with matte colored finished parts. Be sure to consult a Yamaha dealer for advice on what products to use before cleaning the vehicle. Using a brush, harsh chemical products or cleaning compounds when cleaning these parts will scratch or damage their surface. Wax also should not be applied to any matte colored finished parts.

---

## Care

While the open design of a motorcycle reveals the attractiveness of the technology, it also makes it more vulnerable. Rust and corrosion can develop even if high-quality components are used. A rusty exhaust pipe may go unnoticed on a car, however, it detracts from the overall appearance of a motorcycle. Frequent and proper care does not only comply with the terms of the warranty, but it will also keep your motorcycle looking good, extend its life and optimize its performance.

## Before cleaning

1. Cover the muffler outlet with a plastic bag after the engine has cooled down.
2. Make sure that all caps and covers as well as all electrical couplers and connectors, including the spark plug cap, are tightly installed.
3. Remove extremely stubborn dirt, like oil burnt onto the crankcase, with a degreasing agent and a brush, but never apply such products onto seals, gaskets and wheel axles. Always rinse the dirt and degreaser off with water.

## Cleaning

ECA17111

### **NOTICE**

---

- **Avoid using strong acidic wheel cleaners, especially on spoked wheels. If such products are used on hard-to-remove dirt, do not leave the cleaner on the affected area any longer than in-**

# Motorcycle care and storage

structed. Also, thoroughly rinse the area off with water, immediately dry it, and then apply a corrosion protection spray.

- **Improper cleaning can damage plastic parts (such as cowlings, panels, etc.) and the mufflers. Use only a soft, clean cloth or sponge with water to clean plastic. However, if the plastic parts cannot be thoroughly cleaned with water, diluted mild detergent with water may be used. Be sure to rinse off any detergent residue using plenty of water, as it is harmful to plastic parts.**
- **Do not use any harsh chemical products on plastic parts. Be sure to avoid using cloths or sponges which have been in contact with strong or abrasive cleaning products, solvent or thinner, fuel (gasoline), rust removers or inhibitors, brake fluid, antifreeze or electrolyte.**
- **Do not use high-pressure washers or steam-jet cleaners since they cause water seepage and deterioration in the following areas: seals (of wheel and swing-arm bearings, fork and brakes), electric components (couplers, connectors, and switches), breather hoses and vents.**

## After normal use

Remove dirt with warm water, a mild detergent, and a soft, clean sponge, and then rinse thoroughly with clean water. Use a toothbrush or bottlebrush for hard-to-reach areas. Stubborn dirt

and insects will come off more easily if the area is covered with a wet cloth for a few minutes before cleaning.

## After riding in the rain or near the sea

Since sea salt is extremely corrosive, carry out the following steps after each ride in the rain or near the sea.

1. Clean the motorcycle with cold water and a mild detergent, after the engine has cooled down.  
**NOTICE: Do not use warm water since it increases the corrosive action of the salt.** [ECA10792]
2. Apply a corrosion protection spray on all metal, including chrome- and nickel-plated, surfaces to prevent corrosion.

## **After cleaning**

1. Dry the motorcycle with a chamois or an absorbing cloth.
2. Use a chrome polish to shine chrome, aluminum and stainless-steel parts.
3. To prevent corrosion, it is recommended to apply a corrosion protection spray on all metal, including chrome- and nickel-plated, surfaces.
4. Use spray oil as a universal cleaner to remove any remaining dirt.
5. Touch up minor paint damage caused by stones, etc.
6. Wax all painted surfaces.
7. Let the motorcycle dry completely before storing or covering it.

EWA14502



**WARNING**

**Contaminants on the brakes or tires can cause loss of control.**

# Motorcycle care and storage

---

EAU40646

- Make sure that there is no oil or wax on the tires.
- If necessary, wash the tires with warm water and a mild detergent. Before riding at higher speeds, test the motorcycle's braking performance and cornering behavior.

ECA10801

## NOTICE

- Apply spray oil and wax sparingly and make sure to wipe off any excess.
- Never apply oil or wax to any rubber and plastic parts, but treat them with a suitable care product.
- Avoid using abrasive polishing compounds as they will wear away the paint.

## TIP

Consult a Yamaha dealer for advice on what products to use.

## Storage

### Short-term

Always store your motorcycle in a cool, dry place and, if necessary, protect it against dust with a porous cover. Be sure the engine and the exhaust system are cool before covering the motorcycle.

ECA10811

## NOTICE

- Storing the motorcycle in a poorly ventilated room or covering it with a tarp, while it is still wet, will allow water and humidity to seep in and cause rust.
- To prevent corrosion, avoid damp cellars, stables (because of the presence of ammonia) and areas where strong chemicals are stored.

### Long-term

Before storing your motorcycle for several months:

1. Follow all the instructions in the "Care" section of this chapter.
2. For motorcycles equipped with a fuel cock that has an "S" (stop) position: Turn the fuel cock lever to "S".
3. Drain the carburetor float chamber by loosening the drain bolt; this will prevent fuel deposits from building up. Pour the drained fuel into the fuel tank.
4. Fill up the fuel tank and add fuel stabilizer (if available) to prevent the fuel tank from rusting and the fuel from deteriorating.



# Motorcycle care and storage

---

5. Perform the following steps to protect the cylinder, piston rings, etc. from corrosion.
  - a. Remove the spark plug cap and spark plug.
  - b. Pour a teaspoonful of engine oil into the spark plug bore.
  - c. Install the spark plug cap onto the spark plug, and then place the spark plug on the cylinder head so that the electrodes are grounded. (This will limit sparking during the next step.)
  - d. Turn the engine over several times with the starter. (This will coat the cylinder wall with oil.)
  - e. Remove the spark plug cap from the spark plug, and then install the spark plug and the spark plug cap. **WARNING! To prevent damage or injury from sparking, make sure to ground the spark plug electrodes while turning the engine over.** [EWA10952]
6. Lubricate all control cables and the pivoting points of all levers as well as of the centerstand.
7. Check and, if necessary, correct the tire air pressure, and then lift the motorcycle so that both of its wheels are off the ground. Alternatively, turn the wheels a little every month in order to prevent the tires from becoming degraded in one spot.
8. Cover the muffler outlet with a plastic bag to prevent moisture from entering it.

## TIP

---

Make any necessary repairs before storing the motorcycle.

---

# Specifications

---

## Dimensions:

- Overall length:  
1245 mm (49.0 in)
- Overall width:  
610 mm (24.0 in)
- Overall height:  
705 mm (27.8 in)
- Seat height:  
475 mm (18.7 in)
- Wheelbase:  
855 mm (33.7 in)
- Ground clearance:  
95 mm (3.74 in)
- Minimum turning radius:  
1.3 m (4.27 ft)

## Weight:

- Curb weight:  
41 kg (90 lb)
- Maximum rider weight:  
25.0 kg (55 lb)
- Technical permissible mass (Maximum load +  
Curb weight):  
66 kg (146 lb)

## Noise and vibration level: (Europe)

- Noise level (77/311/EEC):  
75.1 dB(A) at 2750 r/min
- Uncertainty of measurement:  
3.0 dB(A)
- Vibration on seat (EN1032, ISO5008):  
Will not exceed 0.5 m/s<sup>2</sup>
- Uncertainty of measurement:  
0.1 m/s<sup>2</sup>
- Vibration on handlebar (EN1032, ISO5008):  
Will not exceed 2.5 m/s<sup>2</sup>
- Uncertainty of measurement:  
0.4 m/s<sup>2</sup>

## Engine:

- Combustion cycle:  
2-stroke
- Cooling system:  
Air cooled
- Number of cylinders:  
Single cylinder
- Displacement:  
49 cm<sup>3</sup>
- Bore × stroke:  
40.0 × 39.2 mm (1.57 × 1.54 in)
- Compression ratio:  
6.0 : 1

- Starting system:  
Kickstarter
- Lubrication system:  
Separate lubrication

## Engine oil:

- Engine oil:  
YAMALUBE 2S or 2-stroke engine oil  
(JASO FC grade or ISO EG-C [or EG-D]  
grade)
- Recommended brand:  
YAMALUBE
- Engine oil quantity:  
Engine oil tank capacity:  
0.30 L (0.32 US qt, 0.26 Imp.qt)

## Transmission oil:

- Type:  
Motor oil SAE 10W-30 type SE or higher or  
Gear oil SAE 85W GL-3
- Quantity:  
0.30 L (0.32 US qt, 0.26 Imp.qt)

## Air filter:

- Air filter element:  
Wet element

## Fuel:

- Recommended fuel:  
Regular unleaded gasoline only
- Fuel tank capacity:  
2.0 L (0.5 US gal, 0.4 Imp.gal)

## Carburetor:

- Type × quantity:  
VM12SC × 1

## Spark plug(s):

- Manufacturer/model:  
NGK/BPR4HS
- Spark plug gap:  
0.6–0.7 mm (0.024–0.028 in)

## Clutch:

- Clutch type:  
Wet, centrifugal, shoe

## Drivetrain:

- Primary reduction ratio:  
1.909 (63/33)
- Final drive:  
Shaft
- Secondary reduction ratio:  
6.218 (19/15 × 54/11)

**Chassis:**

Frame type:  
Backbone  
Caster angle:  
25.5 °  
Trail:  
50 mm (2.0 in)

**Front tire:**

Type:  
With tube  
Size:  
2.50-10 4PR  
Manufacturer/model:  
BRIDGESTONE/M29  
Manufacturer/model:  
IRC/Z MARK II (Canada, Oceania, South Africa)  
Speed rating:  
100 km/h (62 mph)

**Rear tire:**

Type:  
With tube  
Size:  
2.50-10 4PR  
Manufacturer/model:  
BRIDGESTONE/M29  
Manufacturer/model:  
IRC/Z MARK II (Canada, Oceania, South Africa)  
Speed rating:  
100 km/h (62 mph)

**Tire air pressure (measured on cold tires):**

Front:  
100 kPa (1.00 kgf/cm<sup>2</sup>, 15 psi)  
Rear:  
100 kPa (1.00 kgf/cm<sup>2</sup>, 15 psi)

**Front wheel:**

Wheel type:  
Panel wheel  
Rim size:  
10 x 1.50

**Rear wheel:**

Wheel type:  
Panel wheel  
Rim size:  
10 x 1.50

**Front brake:**

Type:  
Mechanical leading trailing drum brake

**Rear brake:**

Type:  
Mechanical leading trailing drum brake

**Front suspension:**

Type:  
Telescopic fork  
Spring:  
Coil spring  
Shock absorber:  
Hydraulic damper  
Wheel travel:  
60 mm (2.4 in)

**Rear suspension:**

Type:  
Unit swing  
Spring:  
Coil spring  
Shock absorber:  
Hydraulic damper  
Wheel travel:  
50 mm (2.0 in)

**Electrical system:**

Ignition system:  
CDI  
Charging system:  
CDI magneto

# Specifications

---

EAU51132

## **For Europe only**

The figures quoted are emission levels and are not necessarily safe working levels. Whilst there is a correlation between the emission and exposure levels, this cannot be used reliably to determine whether or not further precautions are required. Factors that influence the actual level of exposure of work-force include the characteristics of the work room, the other sources of noise, etc. i.e. the number of machines and other adjacent processes, and the length of time for which an operator is exposed to the noise. Also the permissible exposure level can vary from country. This information, however, will enable the user of the machine to make a better evaluation of the hazard and risk.

## Identification numbers

EAU26365

Record the vehicle identification number and the engine serial number in the spaces provided below for assistance when ordering spare parts from a Yamaha dealer or for reference in case the vehicle is stolen.

VEHICLE IDENTIFICATION NUMBER:

ENGINE SERIAL NUMBER:

## Vehicle identification number

EAU26401

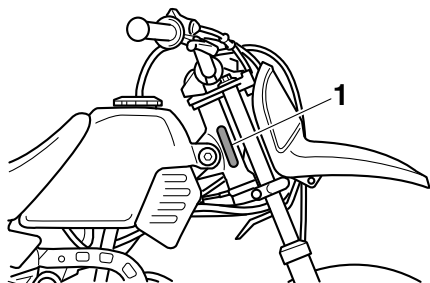

1. Vehicle identification number

The vehicle identification number is stamped into the steering head pipe. Record this number in the space provided.

## TIP

The vehicle identification number is used to identify your motorcycle and may be used to register your motorcycle with the licensing authority in your area.

## Engine serial number

EAU26442

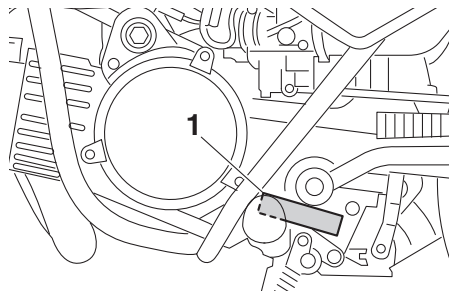

1. Engine serial number

The engine serial number is stamped into the crankcase.

## Vehicle Emission Control Information label (For Canada)

EAU48121

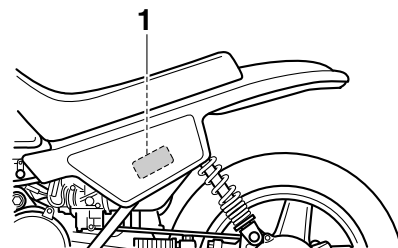

1. Vehicle Emission Control Information label

# Consumer information

---

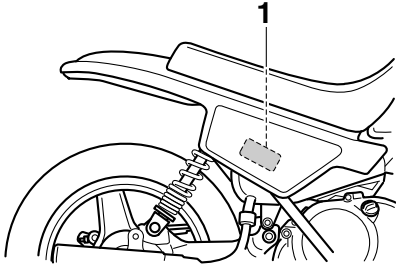

## 1. Vehicle Emission Control Information label

The Vehicle Emission Control Information label is affixed at the location in the illustration. This label shows specifications related to exhaust emissions as required by federal law, state law and Environment Canada.

## **Reporting safety defects (For CANADA customers)**

If you believe that your vehicle has a defect which could cause a crash or could cause injury or death, you should immediately inform Transport Canada in addition to notifying Yamaha Motor Canada Ltd, Canada. If Transport Canada receives similar complaints, it may open an investigation, and if it finds that a safety defect exists in a group of vehicles, it may order a recall and remedy campaign. However, Transport Canada cannot become involved in individual problems between you, your dealer, or Yamaha Motor Canada Ltd., Canada.

To contact Transport Canada, you may call Defect Investigations and Recall Division at 819-994-3328 or toll free 1-800-333-0510, go to [www.tc.gc.ca](http://www.tc.gc.ca) or email: [mvs-sa@tc.gc.ca](mailto:mvs-sa@tc.gc.ca) or write to Transport Canada, 330 Sparks Street Ottawa, ON, K1A 0N5.

You can also obtain other information about motor vehicle safety from [www.tc.gc.ca](http://www.tc.gc.ca).

# Index

---

- A**  
Acceleration and deceleration ..... 6-3  
Air filter element, cleaning ..... 7-10  
Autolube pump, adjusting..... 7-20
- B**  
Brake lever, front ..... 4-2  
Brake lever, rear ..... 4-3  
Brake levers, lubricating ..... 7-20  
Brake shoes, checking ..... 7-18  
Braking..... 6-3
- C**  
Cable lock (for Europe) ..... 4-9  
Cables, checking and lubricating ..... 7-19  
Carburetor, adjusting ..... 7-12  
Care ..... 8-1  
Centerstand, checking and  
lubricating ..... 7-21
- E**  
Engine break-in..... 6-4  
Engine idling speed ..... 7-13  
Engine oil ..... 4-6  
Engine serial number ..... 10-1  
Engine, starting a warm ..... 6-2  
Engine stop switch ..... 4-1
- F**  
Front and rear brake lever free play,  
adjusting ..... 7-17  
Front fork, checking ..... 7-21  
Fuel ..... 4-4  
Fuel cock ..... 4-6  
Fuel tank breather hose ..... 4-5  
Fuel tank cap ..... 4-3
- H**  
Handlebar switch ..... 4-1
- I**  
Identification numbers ..... 10-1
- K**  
Kickstarter..... 4-7
- L**  
Labels, location..... 1-1
- M**  
Maintenance and lubrication, periodic ... 7-4  
Maintenance, emission control  
system ..... 7-3  
Matte color, caution ..... 8-1  
Middle and final gear cases..... 7-10
- P**  
Parking..... 6-4  
Part locations ..... 3-1  
Power reduction plate, removing..... 7-7
- S**  
Safety defects, reporting (For CANADA  
customers) ..... 10-3  
Safety information ..... 2-1  
Seat ..... 4-8  
Spark arrester, cleaning ..... 7-11  
Spark plug, checking ..... 7-6  
Specifications ..... 9-1  
Speed limiter and power reduction  
plate ..... 4-1  
Starter (choke) lever ..... 4-7  
Starting and warming up a cold  
engine ..... 6-1  
Starting off..... 6-2  
Steering, checking..... 7-22  
Storage..... 8-3
- T**  
Throttle grip and cable, checking and  
lubricating ..... 7-19  
Throttle grip free play, checking..... 7-14  
Tires..... 7-14  
Tool kit..... 7-2  
Transmission oil ..... 7-8  
Troubleshooting ..... 7-27  
Troubleshooting chart ..... 7-28
- V**  
Vehicle Emission Control Information  
label (For Canada)..... 10-1  
Vehicle identification number ..... 10-1
- W**  
Wheel bearings, checking ..... 7-22  
Wheel (front) ..... 7-23  
Wheel (rear) ..... 7-24  
Wheels..... 7-16





## **⚠ WARNING**

**Improper motorcycle use can result in SEVERE INJURY or DEATH.**



**ALWAYS USE  
AN APPROVED  
HELMET AND  
PROTECTIVE GEAR**



**NEVER USE  
ON PAVED  
ROADS**



**NEVER CARRY  
PASSENGERS**

### **NEVER operate:**

- without proper training or instruction.
- at speeds too fast for your skills or the conditions.
- on public roads—a collision can occur with another vehicle.
- with a passenger—passengers affect balance and steering and increase risk of losing control.

### **ALWAYS:**

- use proper riding techniques to avoid vehicle overturns on hills and rough terrain and in turns.
- avoid paved surfaces—pavement may seriously affect handling and control.

**LOCATE AND READ OWNER'S MANUAL. FOLLOW ALL INSTRUCTIONS AND WARNINGS.**

